



# D600 User Manual



## Trademark Acknowledgments

- SATIR is trademark of SATIR Europe (Ireland) LTD.
- Microsoft, Windows and Windows logo is either registered trademarks or trademarks of Microsoft Corporation in the United States and/or other countries.
- Other names and products not mentioned above may be registered trademarks or trademarks of their respective companies.

Copyright © 2023 SATIR LTD. All rights reserved.

# About this IR Camera User Guide

## *Symbols Used*



This mark denotes issues that may affect the IR camera's operation.



This mark denotes additional topics that complement the basic operation procedures.

- **What do the icons listed in the Camera User Guide mean?**  
Information displayed on the LCD Display (p.14)

# Thumb Index

Introduction of camera components.

Preparing the  
IR Camera

Describes basic functions, learning how to turn on/off the IR camera and work with the control panel and LCD monitor.

Basic function

Describes working with the camera, from each analysis settings to using the camera's various analysis tools.

Shooting

Explains how to review recorded images, erase images and playback voice memos.

Playback and  
erase

Explains how to transfer images or video to a computer.

Connection  
and download

**You must read this section before connecting your camera to a computer.**

# Table of Contents

<b>ReadThisFirst</b> .....	5
<b>Front View</b> .....	9
<b>Back /Bottom View</b> .....	10
<b>PreparetheIRCamera</b> .....	11
<b>Charge the Device</b> .....	11
<b>Turn the Power On / Off</b> .....	12
<b>Understand the Information on the Display</b> .....	14
<b>Set the date and time</b> .....	16
<b>Local Settings</b> .....	18
<b>Language setting</b> .....	18
<b>Unit setting</b> .....	20
<b>TV-OUT mode</b> .....	21
<b>Quick Launcher</b> .....	23
<b>BasicFunctions</b> .....	25
<b>Use the LCD Display</b> .....	25
<b>Select Menus and Settings</b> .....	26
<b>Reset the Settings to Default</b> .....	28
<b>Shoot</b> .....	29
<b>IR Camera Adjustment</b> .....	29
<b>Focus</b> .....	29
<b>Display Mode</b> .....	31
<b>Image adjustment</b> .....	35
<b>Palette</b> .....	39
<b>Auto Shutter</b> .....	41
<b>Multifunction key</b> .....	43
<b>Turn the LED and Laser on/off</b> .....	45
<b>Laser Dist</b> .....	47
<b>USB Mode</b> .....	49
<b>Bluetooth</b> .....	51
<b>Measurement range</b> .....	52

Freeze/Activate an image.....	54
Emissivity table.....	55
Fulfill the Analysis Function.....	57
Set object/global settings.....	57
Reset the default settings.....	59
Analysis tools.....	60
Alarm temperature.....	69
Comparing temperature.....	70
Remove analysis tools.....	72
Save the Image.....	73
Attach Voice Memos Images.....	75
Snapshot and Edit the image.....	77
Record/Replay the Video.....	79
PlaybackandErase.....	81
Open Images.....	81
File Manager.....	83
ConnectionandDownload.....	86
Download the images.....	86
Connect to a video-compatible monitor.....	87
Connect to a computer.....	88
Real-time transfer.....	89
Use the Bluetooth headset.....	91
Appendix.....	93
How to setup for optional Lens.....	93
Attach Optional Lens.....	94
Remove Optional Lens.....	96
Camera Care and Maintenance.....	97
Emissivity table.....	98
Specification.....	104

# Read This First

## Please Read

### Test Shots

Before you try to shoot important subjects, we highly recommend that you shoot several trial images to confirm that the IR camera is operating and being operated correctly.

Please note that SATIR, its subsidiaries and affiliates, and its distributors are not liable for any consequential damages arising from any malfunction of an IR camera or accessory that results in the failure of an image to be recorded or to be recorded in a format that is machine readable.

### Warning Against Copyright Infringement



### Safety Precautions

Before using the camera, please ensure that you read and understand the safety precautions described below. Always ensure that the IR camera is operated correctly.

The safety precautions noted on the following pages are intended to instruct you in the safe and correct operation of the IR camera and its accessories to prevent injuries or damage to yourself, other persons and equipment.

# Warnings

## Avoid damaging eyesight

**Warning:** Do not trigger the laser pointer in human or animal eyes. Exposure to the laser produced by the laser pointer may damage eyesight.

## Do not disassemble

Do not attempt to disassemble or alter any part of the equipment that is not expressly described in this guide.

## Stop operating immediately if it emits smoke or noxious fumes

Failure to do so may result in fire or electrical shock. Immediately turn the IR camera's power off, Unplug the power cord from the power outlet. Confirm that smoke and fume emissions have ceased.

## Stop operating immediately if it is dropped or the casing is damaged

Failure to do so may result in fire or electrical shock. Immediately turn the IR camera's power off, Unplug the power cord from the power outlet.

## Do not use substances containing alcohol, benzene, thinners or other flammable substances to clean or maintain the IR camera

The use of these substances may lead to fire.

## Remove the power cord on a regular periodic basis and wipe away the dust and dirt that collects on the plug, the exterior of the power outlet and the surrounding area

In dust, humid or greasy environments, the dust that collects around the plug over long periods of time may become saturated with humidity and short-circuit, leading to fire.

**Do not handle the power cord if your hands are wet**

Handling it with wet hands may lead to electrical shock. When unplugging the cord, ensure that you hold the solid portion of the plug. Pulling on the flexible portion of the cord may damage or expose the wire and insulation, creating the potential for fires and electrical shocks.

**Do not cut, alter or place heavy items on the power adapter cord**

Any of these actions may cause an electrical short circuit, which may lead to fire or electrical shock.

**Use only the recommended power accessories**

Use of power sources not expressly recommended for this IR camera may lead to overheating, distortion of the IR camera, fire, electrical shock or other hazards.

**Use only recommended accessories**

**Disconnect the compact power adapter from both the IR camera and power outlet after recharging and when the IR camera is not in use to avoid fires and other hazards**

Continuous use over a long period of time may cause the unit to overheat and distort, resulting in fire.

**Exercise due caution when screwing on the separately sold tele-lens, close-up lens**

If the lens is loosened and fallen off, the glass shards may cause an injury.

**If your camera is used for prolong periods, the IR camera body may become warm**

Please take care when operating the IR camera for an extended period as your hands may experience a burning sensation.



# Prevent Malfunction

## Avoid damaging the detector of the IR camera

**Warning:** Do not aim the IR camera directly into the sun or at other intense heat source which could damage the detector of the IR camera.

## Avoid Condensation Related Problems

Moving the IR camera rapidly between hot and cold temperatures may cause condensation (water droplets) on its external and internal surfaces.

You can avoid this by placing the IR camera in the plastic safety case provided and letting it adjust to temperature changes slowly before removing it from the case.

## If Condensation Forms Inside the IR Camera

Stop using the camera immediately if you detect condensation. Further use may damage the IR camera. Remove the memory card, (if applicable) and unplug power source, from the IR camera and wait until moisture evaporates completely before resuming use.

## Right Reserved

SATIR reserves the right to change the functions and configurations of our products without prior notice.

# Component Guide

## Front View

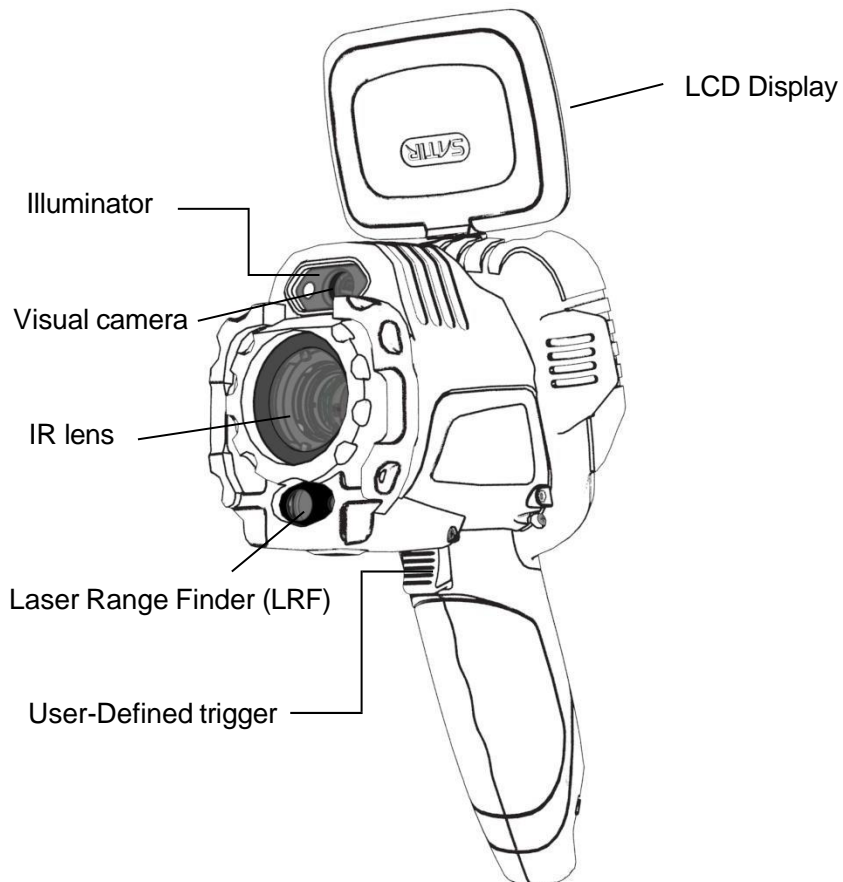

# Component Guide

## Back /Bottom View

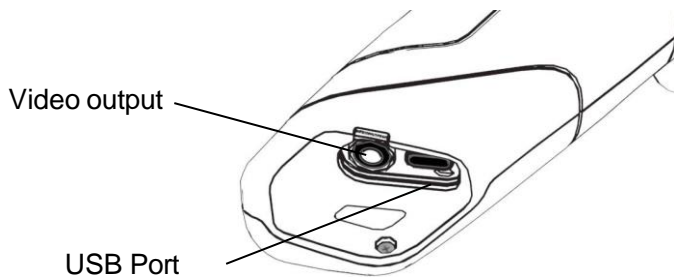
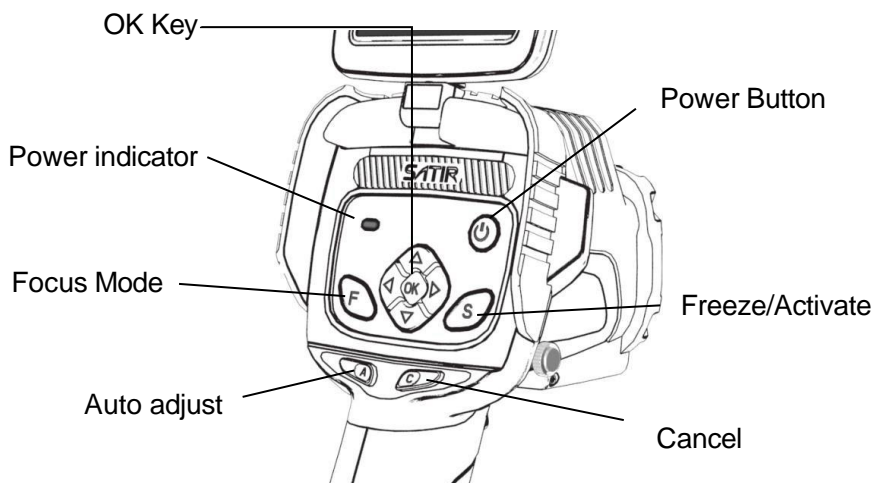

# Prepare the IR Camera



## Charge the Device

### Charge the Device

Device has built in battery, when Low battery status symbols display on User Interface, Please see different battery status symbols below, as well as steps to charge the device.

#### Battery Status Symbols

The following icons indicate the battery status on the LCD display.

	Sufficient battery charge
	Low battery
	Recharge the device

### How to charge device

Only use recommended chargers to recharge the device's battery. To recharge your camera, you can connect the USB cable to the USB port at the bottom of the camera and connect the charger to the other end. Then connect the charger to an electrical outlet.



# Prepare the IR Camera

## Turn the Power On / Off

### Turn the Power On / Off

The control panel back light is illuminated while the camera is powered on.

**1**



To hold the camera correctly in your hand, grip the handle while keeping the device upright, with your thumb placed above the control panel and your index finger on the User-Defined trigger.

**2**

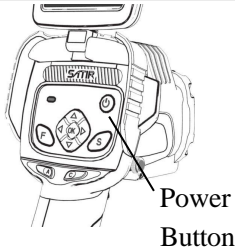

Press and hold the power Button for 3 seconds.

**3**



After approximately 10 seconds, a startup image will appear on the screen.

---

**Turn off the camera.**

**Hold the power button for 3 seconds.**

**4**

- **Select "OK" on the shutdown prompt window. Once the Control Panel is no longer illuminated the device is powered off.**
-

# Prepare the IR Camera

## Understand the Information on the Display

The display has a field of vision of 100% of the actual shooting image. Please see the details for Main User Interface below:

### Main User Interface

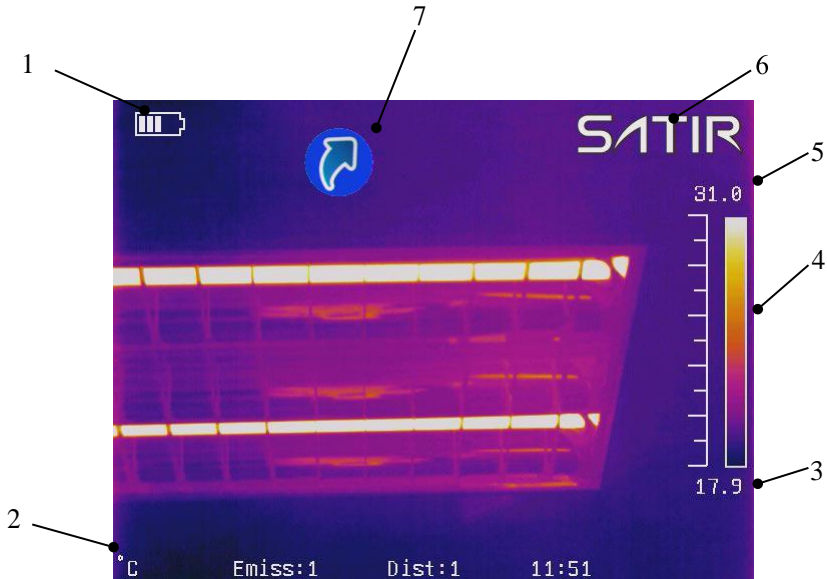

### Explanation:

1	Battery Status Icon
2	Temperature unit; Emissivity; Distance; Time
3	Span(Touch/Select to Modify)
4	Color scale
5	Level(Touch/Select to Modify)
6	SATIR trademark(Touch/Select to open the main menu)
7	Quick launcher (Touch/Select to open the shortcut menu)



## About the system settings

<b>Language</b>	Select the language of the menus and messages
<b>Update</b>	Update operating system
<b>Date &amp; Time</b>	Set the system date and time display ,set time zone and screensavers
<b>Control</b>	Select the video output mode / Activate LED Torch / Activate Laser Range Finder / Set USB Mode / Set the multifunction key
<b>Unit Setting</b>	Set the format of the displayed temperature or distance unit of the camera: °C or °F, Meter or Foot
<b>Power Manager</b>	Set screen saver time / Set power off time



# Prepare the IR Camera

## Set the date and time

### Set the date and time

You need to set the Data / Time when the IR camera is turned on for the first time.

**1** Press the [C] key or Touch/Select the **SATIR** icon.

Press the *UP* or *DOWN* arrow on the omni selector to highlight the  [Settings] menu and press *OK* key to enter.

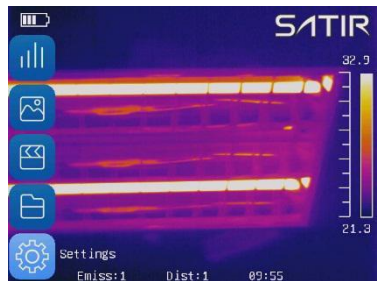

**2** Alternatively, touch/select the [Settings] icon to open the menu.

Press the *UP* or *DOWN* arrow on the omni selector to highlight the  [System] menu and press *OK* key to enter. Highlight and select [Data &

**3** Time] setting.

Alternatively, touch/select the [System] icon to open the menu and touch/select [Date & Time] setting.



---

Use touchscreen, select [Set Date] option:

**4**

- Slide up and down the date item to modify the date;
- After modifying select [OK] to save, changes or select [Cancel] to abandon changes.

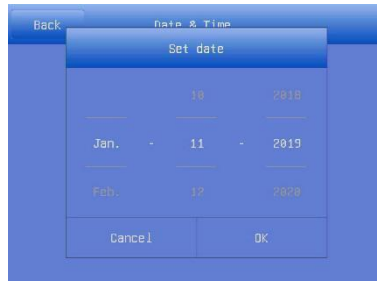

---

Use touchscreen, select [Set Time] option:

**5**

- Slide up and down the time item to modify the time;
- After modifying select [OK] to save, change or select [Cancel] to abandon changes.



---

Use touchscreen, select [Set Timezone] option:

**6**

- Slide up and down the time zone item to modify the time zone;
- After modifying select [OK] to save, change or select [Cancel] to abandon changes.



# Prepare the IR Camera

## Local Settings

In this menu item, you can set style of the built-in menu system.

### Language setting

**1** Press the [C] key or touch/select the **SATIR** icon.

Press the *UP* or *DOWN* arrow on the omni on the selector to highlight the  [Settings] menu and press *OK* key to

**2** enter.

Alternatively, touch/select the [Setting] icon to open the menu.

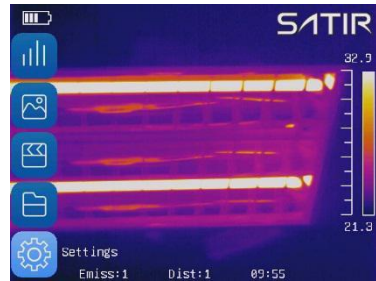

Press the *UP* or *DOWN* arrow on the omni selector to highlight the  [System] menu and press the [OK] Key, then select [Language].

**3** Alternatively, touch/select the [System] icon to open the menu and touch/select [Language] setting.



---

### Local setup:

**4**

- Using the touchscreen, slide up and down to select a language;
- After modifying select [OK] to save, changes or select [Cancel] to abandon changes.

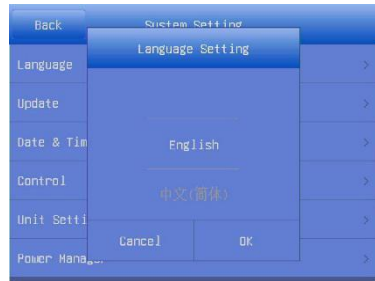

# Prepare the IR Camera

## Local Settings

### Unit setting

- 1 Press the [C] key or touch/select the **SATIR** icon.

Press the *UP* or *DOWN* arrow on the omni selector to highlight  [Settings], then press the *OK* key to enter.

- 2 Alternatively, touch/select the [Setting] icon to open the menu.

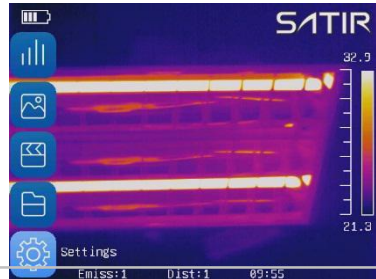

Press the *DOWN* or *UP* arrow on the omni selector to highlight  [System] then press the [OK] Key to enter.

- 3 Then select [Unit Setting]. Alternatively, touch/select the [System] icon to open the menu and touch/select [Unit Setting] option.



Touch to select the unit and select [OK] to finish the setting.

- 4
  - Length: Meter, Feet
  - Temperature: °C, °F

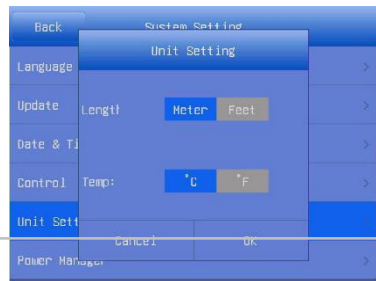

# Prepare the IR Camera

## Local Settings

### TV-OUT mode

**1** Press the [C] key or touch/select the  icon.

**2** Press the *UP* or *DOWN* arrow on the omni selector to highlight  [Settings], then press the *OK* key to enter. Alternatively, touch/select the [Setting] icon to open the menu.

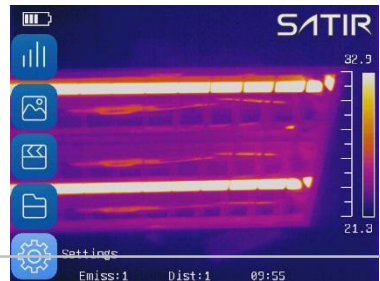

**3** Press the *DOWN* or *UP* arrow on the omni selector to highlight  [System] and press the [OK] Key to enter. Then select [Control]. Alternatively, touch/select the [System] icon to open the menu and touch/select [Control] setting.

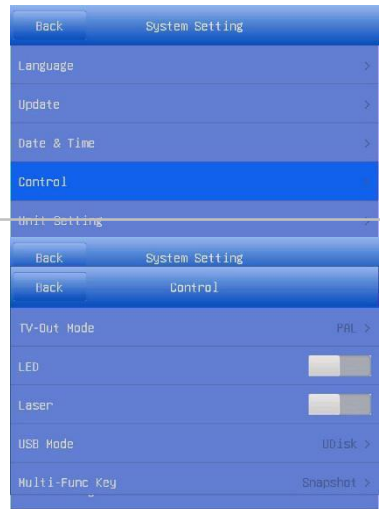

**4** Touch/Select the [TV-OUT Mode]. You can select NTSC or PAL mode, whichever is appropriate for the external monitor.

**5**

Use the arrow buttons, or the touchscreen to select NTSC or PAL mode.



### About Control

<b>TV-OUT Mode</b>	Slide to select the NTSC or PAL mode
<b>LED</b>	Click to open when using CCD in darkness
<b>Laser</b>	Click to open the laser to aim at the object
<b>USB Mode</b>	Slide to select the UDisk or Trans. Mode
<b>Muti-Func. Key</b>	Slide to set the Muti-Function key

# Prepare the IR Camera

## Local Settings

### Quick Launcher

**1** Press the [C] key or touch/select the **SATIR** icon.

Press the *DOWN* or *UP* arrow on the omni selector to highlight  [Settings], then press the *OK* key to enter.

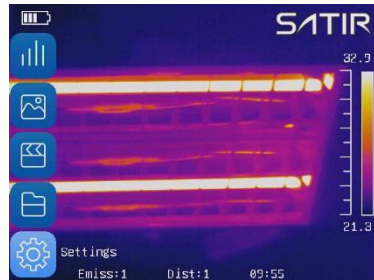

**2** Alternatively, touch/select the [Setting] icon to open the menu.

Press the *DOWN* or *UP* arrow on the omni selector to highlight  [Image] and press the [OK] Key to enter.

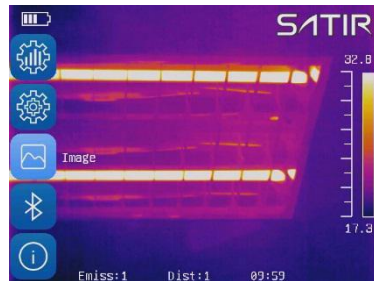

**3** Alternatively, touch/select the [Image] icon to open the menu.

Touch/Select the [ON/OFF] button to the right of [Quick Launcher] to toggle the Quick Launcher feature.





**5** On the main User Interface, touch/select the Quick Launcher icon . The shortcut menu will appear on right area of the User Interface.

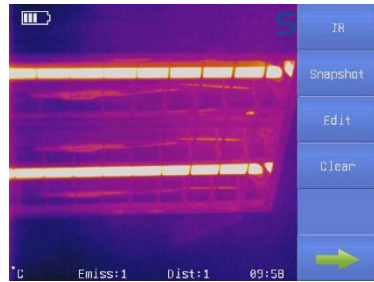

# Basic Functions

## Use the LCD Display

### Use the LCD Display

If you wish to use the LCD display for shooting, playing back thermal images and adjusting menu settings, follow the instructions below.

---

- 1** Open the LCD Display in the direction of the arrow.

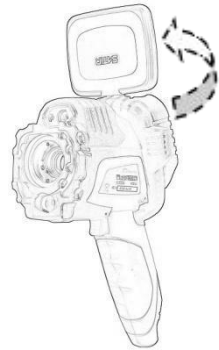

- 2** Aim the IR camera at a subject.
- 



1. For a better temperature measurement, please align the subject to the center of the image that is shown on the LCD Display.
  2. The LCD Display will turn off when it is closed.
-

# Basic Functions

## Select Menus and Settings



To enter the Main Menu, press [C] or touch the [SATIR] logo on the Main User Interface.  
To navigate the menus, use the directional keys to highlight the desired sub-menu icon and press [OK] to enter the menu.  
Alternatively, you can use the touchscreen to navigate the menu by touching the desired sub-menu icon to enter that menu.

**1** Press [C] key  
Or touch the  
SATIR logo

**2** Select a function item using



Or by touching the Icon on the  
User Interface

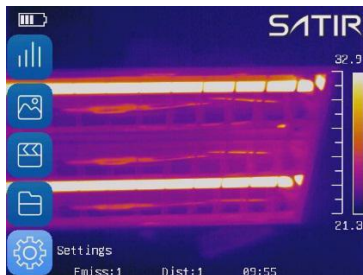



## Main menu

	<b>Analysis(Spot / Area / Line tool and ISO)</b>
	<b>Images(Image mode / Palette / Adjust )</b>
	<b>Media(Snapshot / Edit / Voice record / Video record / Replay)</b>
	<b>File(Review files and thermal images)</b>
	<b>Settings(Analysis setting / System setting / Image setting / Bluetooth / System info)</b>

# Basic Functions

## Reset the Settings to Default

You can reset the menu and button operation settings to default.

**1** Press the [C] key or touch/select the **SATIR** icon.

**2** Press the *DOWN* or *UP* arrow on the omni selector to highlight  [Settings], then press the OK key to enter.

Alternatively, touch/select the [Setting] icon to open the menu.

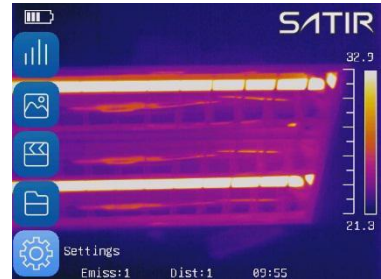

**3** Press the *DOWN* or *UP* arrow on the omni selector to highlight  [System Info] and press the [OK] Key to enter.

Alternatively, touch/select the [System Info] icon to open the menu.



**4** Touch/select [Default Settings].  
The machine will reboot after reset.



After factory defaults, all the user data will delete. You'd better backup user data before factory default.

# Shoot

## IR Camera Adjustment

### Focus

- 1 Aim the IR camera at the subject.

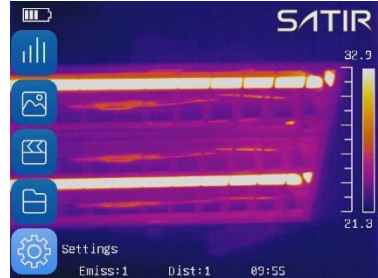

**A:** Press [F] key, [F] key will turn blue which means device is in Focus mode.

- 2 **B:** Press *UP* or *DOWN* arrow to manual focus or press the *LEFT* arrow to auto focus

Alternatively, while in Focus Mode, touch/select the point on the image to automatically focus on that point/object.

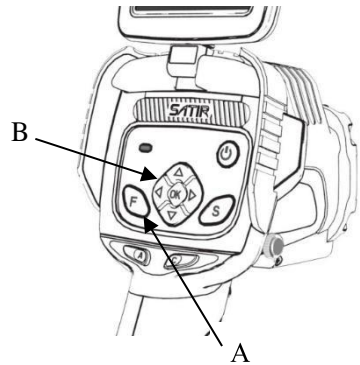

- 3 If focusing manually, adjust the focus until the desired target is clear.  
If using auto focus, hold the camera steady so it can focus on the desired target.



---

## DIGITAL ZOOM

- 4** To use the Digital Zoom feature, ensure the camera is not in Focus Mode, and hold down the [←] button and press [↑] or [↓] to zoom in and out respectively. "Zoom: xxx%" will appear in the middle of the left side the User Interface.

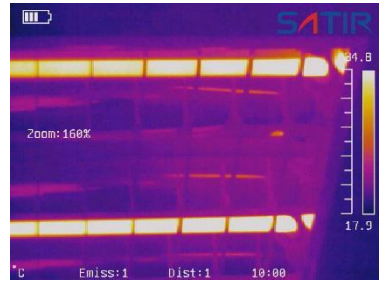

# Shoot

## IR Camera Adjustment

### Display Mode

#### Thermal, Visual and DuoVision image display

This IR camera records visual images with its built-in digital camera. You can capture a visual image as a reference to the thermal image.

**1** Press [C] button, or touch/select the **SATIR** logo.

Press the *DOWN* or *UP* arrow on the omni to selector to highlight  [Image] and press [OK] to enter the menu.

**2**

Alternatively, touch/select the [Image] menu icon to enter the menu.

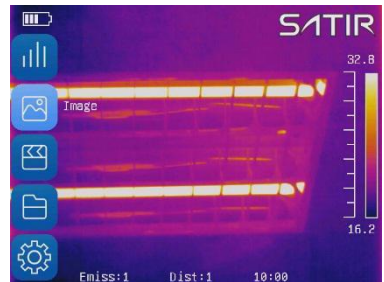

If necessary, use the arrow buttons to highlight the  [Mode] menu icon and press [OK] to enter the menu.

**3**

Alternatively, touch/select the [Mode] menu icon to enter the menu.

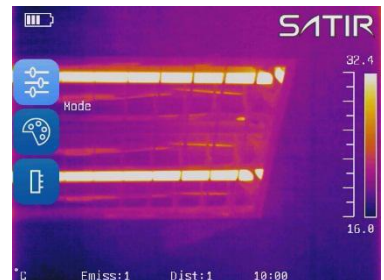



**4**

Use the arrow buttons or the touchscreen, navigate to desired image mode: IR, CCD, Merge, Merge Plus or Image Only.

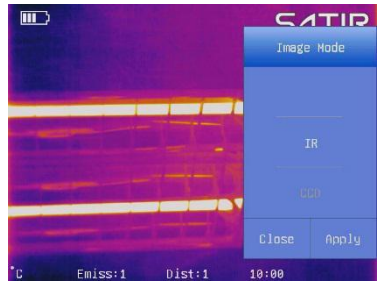

**5**

Alternatively, use the Quick Launcher menu and touch/select the top button, by default his is [IR], to switch between the different modes. To close the Quick Launcher menu press [C] or touch a different area of the User Interface.

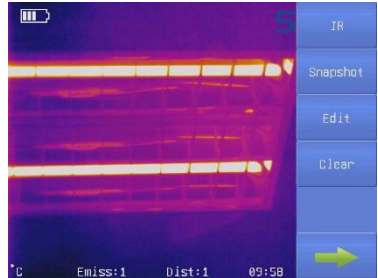

# Shoot

## IR Camera Adjustment



In DuoVision and DuoVisionPlus modes, you can merge the IR image and the visible image to create a more detailed image where text/signs is legible.

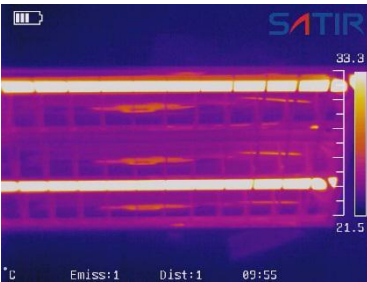

### IR

In this mode, the IR information is displayed in the user defined pseudo color for easy analysis. Analysis tools can be used in this mode.



### CCD

In this mode, you can see the image with full color. Analysis tools cannot be used while in this imaging mode.

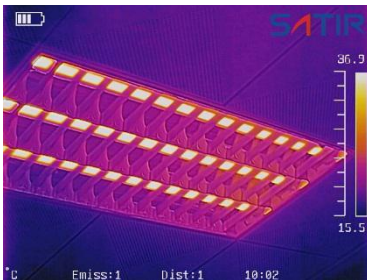

### Merge & Merge Plus

In these image modes, the background image is the visible image and IR image is centered onto the background merging the IR and visible images together.

Merge Plus also outlines geometric shapes providing greater definition to the image. Analysis tools can be used in this mode to analyze targets.



In either merge mode, the user can select the [Pos] function, this allows the user to align the IR and Visible images so they correspond correctly. To do this select [Pos] and using the touch screen move the image until both are aligned on the target.

## Move the fusion square

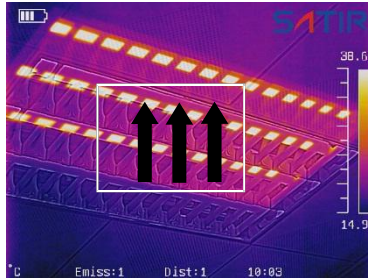

### About the IR/Visible settings

**Percentage** Sets the ratio of IR images and Visual images. The value is from 1% to 100%. This is only available in Merge mode. Not Merge Plus.

# Shoot

## IR Camera Adjustment

### Image adjustment

You can adjust the Level (brightness) and Span (contrast) of the image captured by IR camera, manually or automatically.

### Auto adjustment

- 1 Press [C] button, or touch/select the **SATIR** logo.

Use arrow buttons to highlight  [Image] and press [OK] to enter the menu.

- 2 Alternatively, touch/select the [Image] menu icon to enter the menu.

Use the omni-selector to highlight the  [Adjust] and press [OK] to enter the menu.

- 3 Alternatively, touch/select the [Adjust] menu icon to enter the menu.

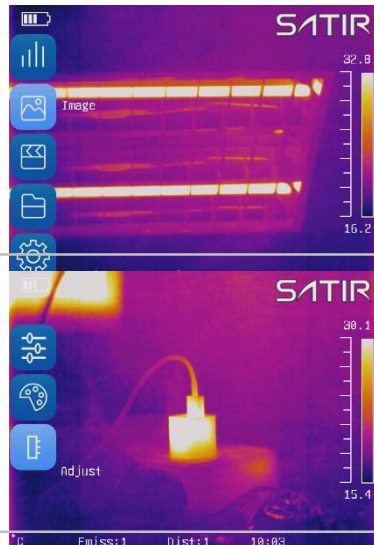

- 
- 4** Use the arrow buttons or touch screen, set the Adjust Mode to [Auto], [Manual] or [Fixed] and hit [Apply].

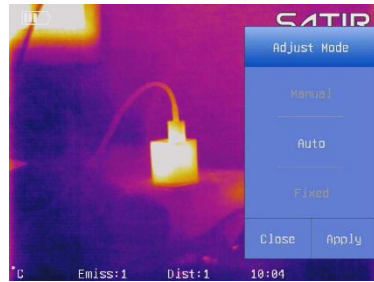

- 
- 5** The IR camera will automatically adjust the brightness and/or contrast and calibrate when you press the [A] key.
-

# Shoot

## IR Camera Adjustment

### Manual Adjustment

- 1 Set device adjust mode to Manual. How to set please refer to P35-36

- 2 The user can touch/select the values above or below the color bar to manually adjust the Level or Span values. Please see the figure to the right.

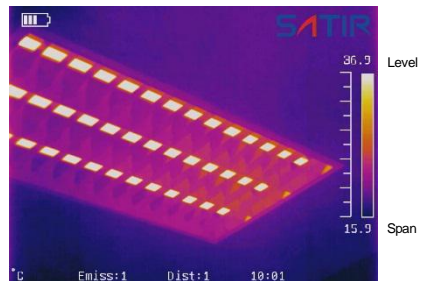

To adjust maximum temperature:

- 3
  - a. Tap the number above the color scale
  - b. Use the arrow buttons or touch screen, select the value of the Max Temp and touch/select [close] to finish the change.



To adjust minimum temperature:

- 4
  - a. Tap the number below the color scale
  - b. Use the arrow buttons or touch screen, select the value of the Min Temp and touch/select [close] to save it.



# Shoot

## IR Camera Adjustment

### Fixed Adjustment

- 1** Set device adjust mode to Fixed. How to set please refer to P35-36.

- 2** In this mode, you can find an F on the left of Level values.

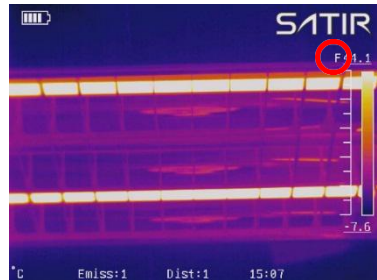

- 3** In this mode, the brightness and contrast will keep the same when you press the [A] key. You only can manually adjust the Span or Level values. How to manually adjust please refer to P37.

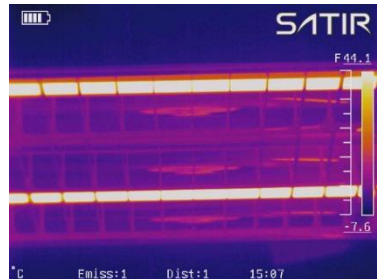

# Shoot

## IR Camera Adjustment

### Palette

**1** Press the [C] key or touch/select the **SATIR** icon.

Use arrow buttons to highlight  [Image] and press [OK] to enter the menu.

**2** Alternatively, touch/select the [Image] menu icon to enter the menu.

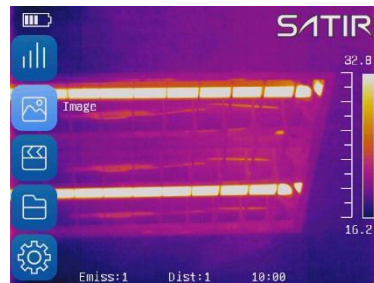

Use the omni-selector to highlight the  [Palette], and press [OK] to enter the menu.

**3** Alternatively, touch/select the [Palette] icon to enter the menu.





---

**4** Use the arrow buttons or touch screen to select the palette mode and then tap [Close] to save the setting.

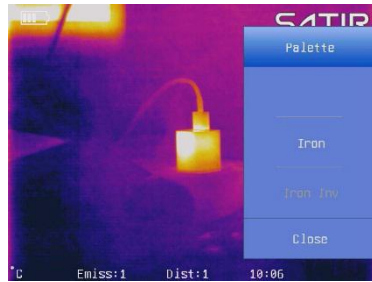

There are 6 color palettes available: Iron, Iron inverted, Rainbow, Feather, Grey and Grey inverted.

# Shoot

## IR Camera Adjustment

### Auto Shutter

- 1 Press the [C] key or touch/select the **SATIR** icon.

Press the *DOWN* or *UP* arrow on the omni selector to

highlight  [Settings], then

- 2 Alternatively, touch/select the [Setting] icon to open the menu.

Press the *DOWN* or *UP* arrow on the omni selector to

highlight  [Image] and press the [OK] Key to enter the menu. Use the omni selector to highlight the

- 3 [Shutter Interval] option and press [OK] to enter.

Alternatively, touch/select the [Image] icon to open the menu, and touch/select the [Shutter Interval] option.

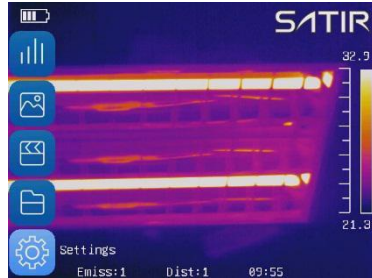

**4**

Use the omni selector or touch screen to set the shutter interval to the desired value and press [OK] or touch/select [Close] to save the setting.



# Shoot

## IR Camera Adjustment

You can set the multifunction key with different functions such as shutter, freeze and snapshot through the system.

## Multifunction key

**1** Press the [C] key or touch/select the **SATIR** icon.

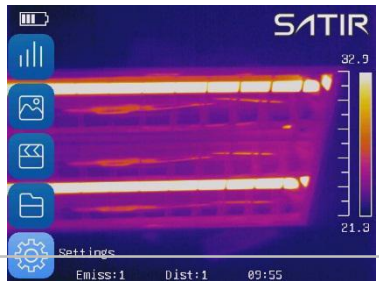

**2** Press the *DOWN* or *UP* arrow on the omni selector to highlight  [Settings], then press the *OK* key to enter. Alternatively, touch/select the [Setting] icon to open the menu.

Press the *DOWN* or *UP* arrow on the omni selector to highlight  [System] and press the [OK] Key to enter. Then select [Control].

**3** Alternatively, touch/select the [System] icon to open the menu and touch/select [Control] setting.

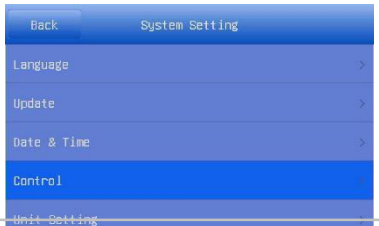

**4** Select [Multi-function Key] option, select desired function using the keypad or touchscreen, then tap [Done] to save the setting.





## About the function of multifunction key

<b>Shutter</b>	The machine will shutter one time by pressing the multifunction key.
<b>Freeze</b>	You can activate / freeze a thermal image by pressing the multifunction key.
<b>Snapshot</b>	Save the image by pressing the multifunction key.
<b>Laser</b>	Open laser by pressing the multifunction key.
<b>LaserDist</b>	Use laser to measure the distance by pressing the multifunction key.
<b>LED</b>	You can turn on/off LED by pressing the multifunction key.

# Shoot

## IR Camera Adjustment

### Turn the LED and Laser on/off

**Warning:** Do not trigger the laser in human or animal eyes. Exposure to the light produced by the laser may damage eyesight.

**1** Press the [C] key or touch/select the **SATIR** icon.

Press the **DOWN** or **UP** arrow on the omni selector to highlight  [Settings], then press the **OK** key to enter.

**2** Alternatively, touch/select the [Setting] Icon to open the menu.

Press the **DOWN** or **UP** arrow on the omni selector to highlight  [System] and press the [OK] Key to enter.

**3** Then select [Control]. Alternatively, touch/select the [System] Icon to open the menu and touch/select [Control] setting.

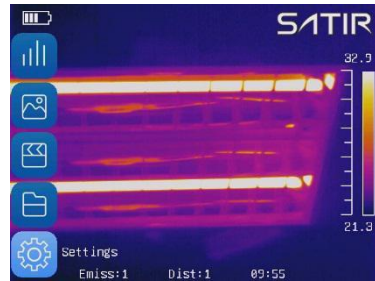

---

**4** Use the omni-selector or touch screen, the user can toggle on/off the LED Torch and the Laser Range Finder. Touch the on/off toggle switch, or highlight the desired function and press [OK] to toggle on/off.

---



# Shoot

## IR Camera Adjustment

### Laser Dist

**Warning:** Do not trigger the laser in human or animal eyes. Exposure to the light produced by the laser may damage eyesight.

- 1 Press the [C] key or touch/select the **SATIR** icon.

Press the **DOWN** or **UP** arrow on the omni selector to highlight  [Settings], then press the **OK** key to enter.

- 2 Alternatively, touch/select the [Setting] icon to open the menu.

Press the **DOWN** or **UP** arrow on the omni selector to highlight  [System] and press the [OK] Key to enter.

- 3 Then select [Control]. Alternatively, touch/select the [System] icon to open the menu and touch/select [Control] setting.

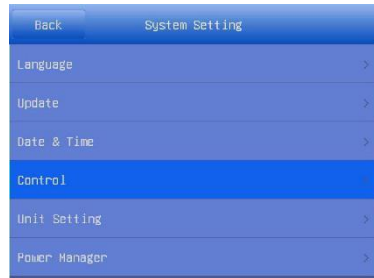
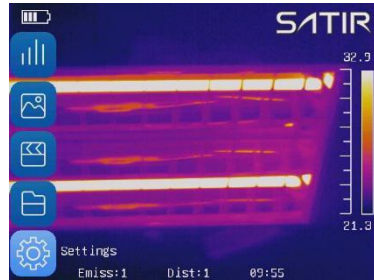



**4** Use the omni-selector or touch screen, toggle on the Laser Range Finder.



**5** Select [Multi-function Key] option, select [LaserDist] function using the keypad or touchscreen, then tap [Done] to save the setting.



**6** Press [C] Key to or use touchscreen to go back to the main user interface. You can measure the distance by press the Multi-function Key. And you can see the number of distance in the bottom right corner of the user interface.



# Shoot

## IR Camera Adjustment

### USB Mode

- 1 Press the [C] key or click the **SATIR** icon.

Press the **DOWN** or **UP** arrow on the omni selector to

highlight  [Settings], then press the **OK** key to enter.

- 2 Alternatively, touch/select the [Setting] icon to open the menu.

Press the **DOWN** or **UP** arrow on the omni selector to

highlight  [System] and press the **[OK]** Key to enter.

Then highlight the [Control] option and press **[OK]** to enter. Navigate to “USB Mode”

- 3 and press **[OK]**.

Alternatively, touch/select the [System] icon to open the menu and touch/select [Control] setting to open the menu and touch/select the [USB Mode] option.

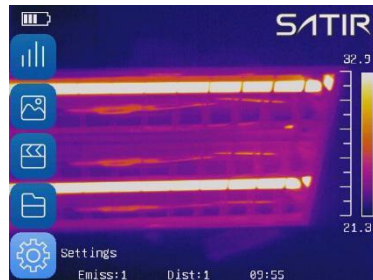

---

**4** Use keypad or touch screen to select [UDisk] or [Trans.] mode and then c tap [Done] to save the setting.



# Shoot

## IR Camera Adjustment

### Bluetooth

- 1 Press the [C] key or touch/select the **SATIR** icon.

Press the *DOWN* or *UP* arrow on the omni selector to

- 2 highlight  [Settings], then press the *OK* key to enter.  
Alternatively, touch/select the [Setting] Icon to open the menu.

Press the *DOWN* arrow on the omni selector to highlight  [Bluetooth] then press the *OK* key to enter.

- 3 Alternatively, touch/select the [Bluetooth] Icon to open the menu.

Press the *DOWN* or *UP* arrow on the omni selector to select the [Start Bluetooth] and press the *OK* key to edit the name of the camera's Bluetooth.

4

Alternatively, touch/select the [Start Bluetooth].



# Shoot

## IR Camera Adjustment

### Measurement range

- 1 Press the [C] key or touch/select the **SATIR** icon.

Press the **DOWN** or **UP** arrow on the omni selector to highlight  [Settings], then press the **OK** key to

- 2 enter.

Alternatively, touch/select the [Setting] icon to open the menu.



Press the **UP** arrow on the omni selector to select the  [Analysis] then select the [Temp. Range].

- 3

Alternatively, touch/select the [Analysis] tab then [Temp. Range] to open the menu.

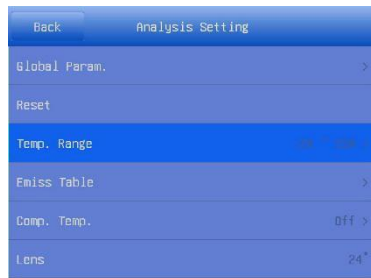

---

**4** Touch/select the number representing the desired range and click [OK] to save the settings. Then press the [C] key to go back to the main interface.

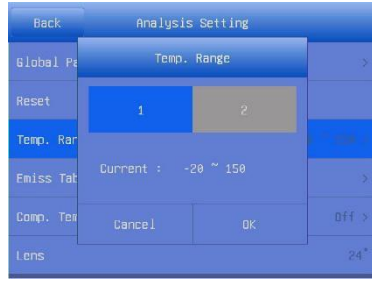

The camera offers two Temp. Range: -20~150°C,140~600°C.

# Shoot

## IR Camera Adjustment

### Freeze/Activate an image

You can activate / freeze a thermal image by pressing the **[S]** key on the keypad.

**1**

Press the **[S]** key to freeze the image. You can see *Freeze* in the bottom left corner of the user interface.



**2**

Press the **[S]** key again to unfreeze/activate the image.



# Shoot

## IR Camera Adjustment

### Emissivity table

- 1 Press the [C] key or touch/select the **SATIR** icon.

Press the *DOWN* or *UP* arrow on the omni selector to highlight  [Settings], then press the *OK* key to enter.

2

Alternatively, touch/select the [Setting] icon to open the menu.

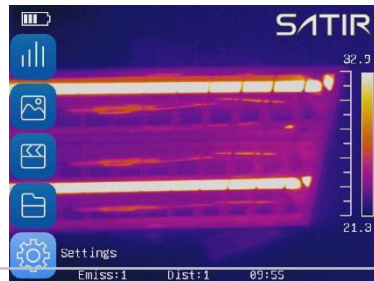

Press *DOWN* or *UP* arrow on the omni selector to select  [Analysis], then select [Emiss Table] press [OK] to enter.

3

Alternatively, touch/select the [Analysis] tab then [Emiss Table] to open the sample Emissivity table.

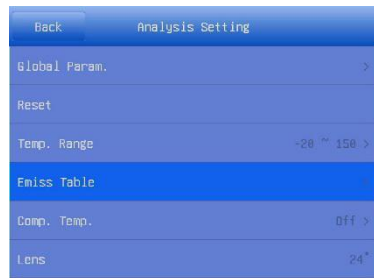



**4**

Use the omni-selector to navigate the table until the desired target material emissivity is found. Press the [C] key to exit the table. Alternatively, navigate the table by using the touchscreen.

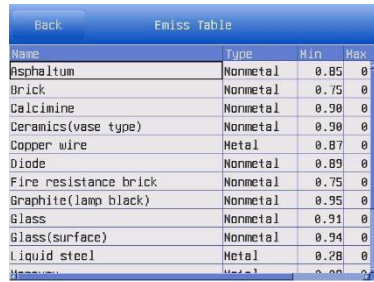

Name	Type	Min	Max
Asphaltum	Nonmetal	0.85	0
Brick	Nonmetal	0.75	0
Calcimine	Nonmetal	0.98	0
Ceramics(vase type)	Nonmetal	0.98	0
Copper wire	Metal	0.87	0
Diode	Nonmetal	0.89	0
Fire resistance brick	Nonmetal	0.75	0
Graphite(lamp black)	Nonmetal	0.95	0
Glass	Nonmetal	0.91	0
Glass(surface)	Nonmetal	0.94	0
Liquid steel	Metal	0.28	0
Lead	Metal	0.28	0

# Shooting

## Fulfill the Analysis Function

### Set object/global settings

**1** Press the [C] key or touch/select the **SATIR** icon.

Press the **DOWN** or **UP** arrow on the omni selector to highlight  [Settings], then press the **OK** key to enter.

**2** Alternatively, touch/select the [Setting] icon to open the menu.

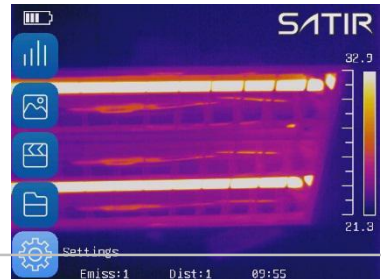

Press the **DOWN** or **UP** arrow on the omni selector to select the  [Analysis] then select the [Global Param.].

**3** Alternatively, touch/select the [Analysis] tab then [Global Param.] to open the settings menu.

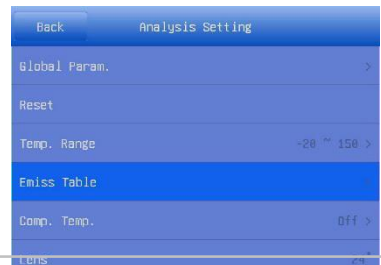

#### Set analysis parameter

- 4**
- Press the **UP** or **DOWN** arrow on the omni selector to select an item to change.
  - Press the **LEFT** or **RIGHT** arrow on the omni selector to set the values.

Alternatively, use the touchscreen to adjust the values.



---

## 5 Tap [Save] to save the settings.

---



### About the analysis parameters

<b>Object</b>	Selects the object of which you want to set the parameters
<b>Emissivity</b>	Different material has different emissivity. Use different emissivity to measure different material
<b>Distance</b>	Different object has different distance to the IR camera. Use different distance to measure different object
<b>Ambi. Temp</b>	Input ambient temperature
<b>Refl. Temp</b>	Input reference temperature
<b>Humidity</b>	Input ambient humidity
<b>Offset</b>	Offset the measurement temperature
<b>Background</b>	Hide or show the background

# Shoot

## Fulfill the Analysis Function

### Reset the default settings

- 1 Press the [C] key or touch/select the **SATIR** icon.

Press the *DOWN* or *UP* arrow on the omni selector to

- 2 highlight  [Settings], then press the *OK* key to enter. Alternatively, touch/select the [Setting] icon to open the menu.

Press the *DOWN* or *UP* arrow on the omni selector to select

- 3  [Analysis] and click [Reset]. Alternatively, touch/select the [Analysis] tab then [Reset] to reset the values to default.

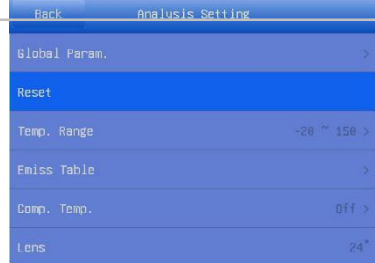

- 4 Tap [OK] to save the setting.



# Shoot

## Fulfill the Analysis Function

### Analysis tools

This topic briefly explains how to set the analysis tools on the thermal image.

### Spot analysis

**1** Press the [C] key or touch/select the **SATIR** icon.

**2** Press the *UP* or *DOWN* arrow on the omni selector to select the  [Analyze] then press [OK] key. Alternatively, touch/select the [Analyze] Icon to open the menu.



**3** Press the *UP* or *DOWN* arrow on the omni selector to select the  [Spot] then press [OK] key or touch/select icon.



---

### Set the spot analysis:

4

- Press the arrow keys and choose a spot, then press the *ok* key or double tap Spot tool.
- Press the *UP* or *DOWN* arrow on the omni selector to select what you want to be changed ,then press the *LEFT* or *RIGHT* arrow on the omni selector to change it.

Alternatively, use the touchscreen to adjust the settings.



---

### Move the spot:

5

- Select spot. Spot turn to green.
- Press the *UP*, *DOWN*, *LEFT*, *RIGHT* arrow on the omni selector to move the spot or, using touchscreen, drag Spot tool to desired point.



---

### Remove the spot:

6

- Select the spot you want to remove, a trashcan appears on the bottom right corner of the UI. Use the touchscreen to drag the Spot tool to the trashcan to remove it.



# Shoot

## Fulfill the Analysis Function

### Area analysis

**1** Press the [C] key or touch/select the **SATIR** icon.

Press the *UP* or *DOWN* arrow on the omni selector to select the 

**2** [Analyze] then press [OK] key.  
Alternatively, touch/select the [Analyze] icon to open the menu.



Press the *UP* or *DOWN* arrow on the omni selector to select the 

**3** [Area] then press [OK] key or touch/select icon.



Set the analysis area:

- 4**
- Use the touchscreen to drag one of the corners to adjust the size of the Area tool.
  - Double tap the center of the Area tool to open the menu bar, then select the desired options to adjust them on the screen.



---

### Move the area:

- Select the area you want to move by tapping the area.
- There are two methods to move the tool:

5

**Method 1:** Press the *UP*, *DOWN*, *LEFT*, *RIGHT* arrow on the omni selector to move the area.

**Method 2:** Use the touchscreen to select the area you want to move and drag it to desired point.



---

### Remove the area:

- Use the touchscreen to select of the Area tool you want to remove, a trashcan will appear on the bottom right of the UI. Drag the undesired Area tool to the trashcan to remove it.

6

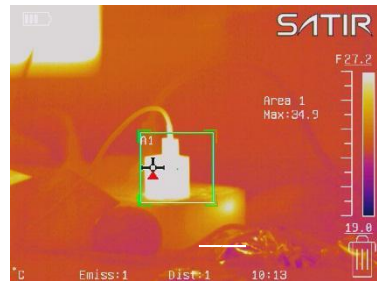

---

### Change the shape of the analysis area:

- Select the area you want to move by using the touchscreen.
- By pressing LEFT and UP you can elongated the length of the area on vertical direction;  
By pressing LEFT and DOWN you can shorten the length of the area on vertical direction;
- By pressing RIGHT and UP you can elongated the length of the area on horizontal direction;  
By pressing RIGHT and DOWN you can shorten the length of the area on horizontal direction.
- Alternatively, use the touchscreen to select a corner of the Area tool, and drag the corner until the Area tool is the desired size.

7



## About changing the shape of the analysis area.

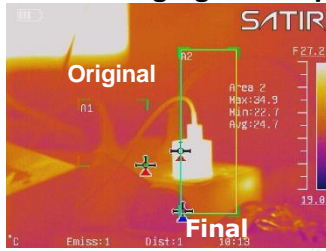

**LEFT and UP**

**LEFT and DOWN**

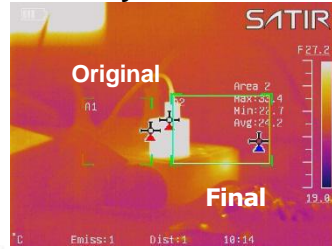

**RIGHT and UP**

**RIGHT and DOWN**

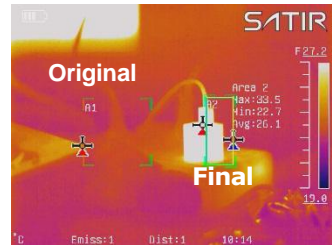

# Shoot

## Fulfill the Analysis Function

### Line analysis

**1** Press the [C] key or touch/select the **SATIR** icon.

Press the *UP* or *DOWN* arrow on the omni selector to select the 

**2** [Analyze] then press [OK] key.

Alternatively, touch/select the [Analyze] icon to open the menu.



**3** Press the *UP* or *DOWN* arrow on the omni selector to select the  [Line] then press [OK] key or touch/select icon.



---

### Move the line:

- Select the line you want to move by tapping the line.
- There are two methods to move the tool:

**4**

**Method 1:** Press the *UP&DOWN* arrow keys to move the line; press the *LEFT&RIGHT* arrow keys on the omni selector to move the triangle.

**Method 2:** Use the touchscreen to drag the Line tool, up or down to the desired position. Select the Triangle and drag it left or right to the desired position.

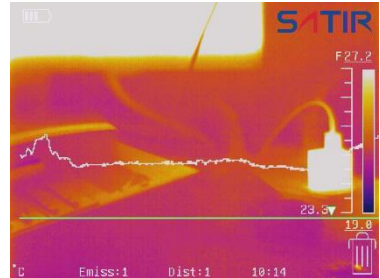

---

### Remove the line:

- Use the touchscreen to select the triangle on the Line tool, a trashcan will appear in the bottom right corner of the UI. Drag the Line tool to the trashcan to remove it.

**5**

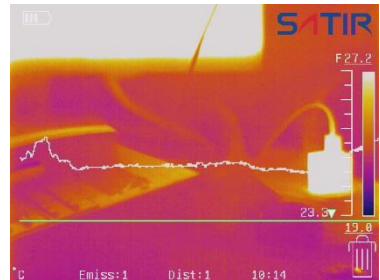

# Shoot

## Fulfill the Analysis Function

### Isotherm analysis

**1** Press the [C] key or touch/select the **SATIR** icon.

Press the *UP* or *DOWN* arrow on the omni selector to select the  [Analyze] then press [OK]

**2** key.

Alternatively, touch/select the [Analyze] Icon to open the menu.



**3** Press the *UP* or *DOWN* arrow on the omni selector to select the  [ISO] press [OK] key or touch/select icon.



### Set isotherm range:

- Start from Step 1 to set or select isotherm analysis.
- Method 1: Press **UP** or **DOWN** arrow to select upper limit or lower limit. Press **LEFT** or **RIGHT** arrow to adjust the number.

**4**

Method 2: Tap +/- beside the number to adjust the values.



### About the ISO mode

Under Below	Use the same color to indicate the isothermal zone and below the lower limit of the isothermal zone.
Over Above	Use the same color to indicate the isothermal zone and above the upper range of the isotherm.
Interval	Use the same color to indicate the isothermal section, the rest of the normal display pseudo-color mode.
Dual Below	Use the same color to indicate the isothermal zone and the other color to indicate below the lower limit of the isothermal zone.
Dual Above	Use the same color to indicate the isothermal zone and other color to indicate above the upper range of the isotherm.

# Shoot

## Fulfill the Analysis Function

### Alarm temperature

**1** Press the [C] key or touch/select the **SATIR** icon.

**2** Add a analyze spot tool, then press the [OK] key again or double tap spot to call the setting window of the spot.



**3** Press *UP* or *DOWN* arrow on the omni selector to highlight [Alarm Temp] or [Alarm Mode], press *LEFT* or *RIGHT* arrow to set the value of alarm temperature or mode.

Alternatively, use the touchscreen to select [Alarm Temp] or [Alarm Mode] to set the value of alarm temperature or mode.



# Shoot

## Fulfill the Analysis Function

### Comparing temperature

**1** Press the [C] key or touch/select the **SATIR** icon.

**2** Add an area analysis tools.

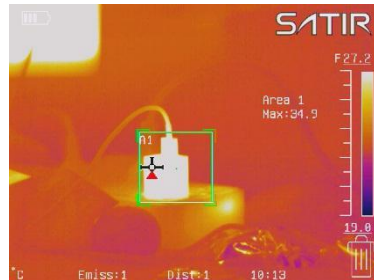

Press the [C] key.

Press **UP&DOWN** arrow to highlight  [Settings] and press the [OK] key to enter.

Press the **UP&DOWN** arrow on the omni selector to highlight the  [Analysis]

**3** and press the [OK] key to enter. Then highlight the [Comp. Temp.] and press the [OK] key to enter.

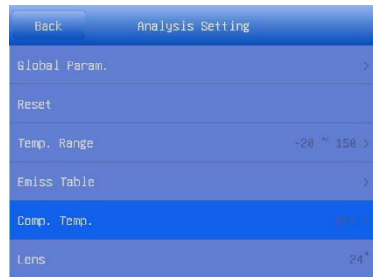

Alternatively, touch/select the [Settings] → [Analysis] tab then [Comp. Temp.] to open the settings menu.

- 
- 4** Tap the switch upper *right* corner of the interface.  
Tap to select the target and base, touch/select [+/-] to set the value of reference temperature.



- 
- 5** Press the [C] key twice to back to the main interface.  
Press the [C] key again to hide the menu.  
You can see the values of difference beside 'Comp:' on downer right area of the screen.
-



# Shoot

## Fulfill the Analysis Function

### Remove analysis tools

This topic briefly explains how to remove all analysis tools you place on the screen.

- 1** Touch/select the  icon on the screen. How to call Quick Launcher, please refer to p23.

- 2** In the pop-up menu bar on the right side touch/select [Clear] key to clear all the analysis tools.

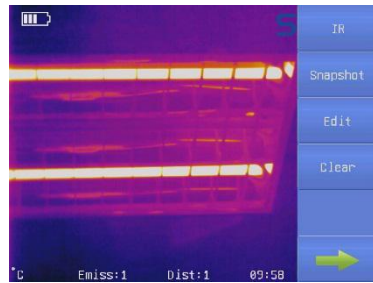

# Shoot

## Save the Image

This topic briefly explains how to save your Image.

**1** Press the [C] key or touch/select the **SATIR** icon.

Press the *UP* or *DOWN* arrow on the omni selector to highlight the  [Media] menu, then press the OK key to enter.

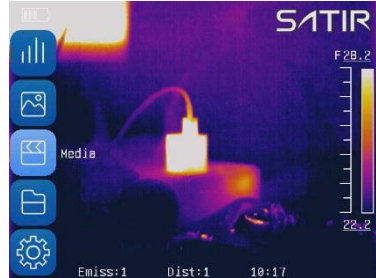

Alternatively, touch/select the [Media] Icon to open the menu.

**3** Press the *UP* or *DOWN* arrow on the omni selector to highlight the  [Snapshot] and press the OK key.



Alternatively, touch/select the [Snapshot] Icon to save the Image.

**4** Successfully saved there will have a sign be displayed on the screen.

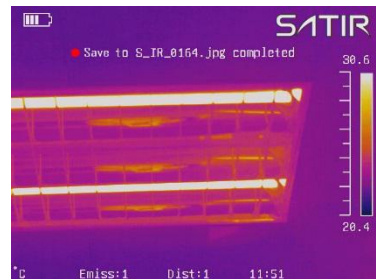

**5** Alternatively, you can touch/select the  icon on the screen. In the pop-up menu bar on the right side, touch/select [snapshot] key to save the image.

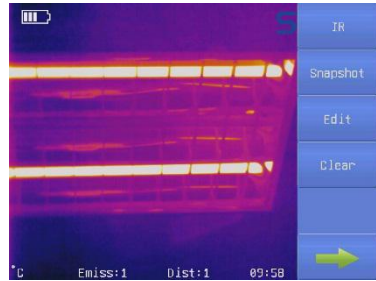

**Tips:** You'd better freeze your Image before saving it. How to freeze your Image, you can refer to P54.

# Shoot

## Attach Voice Memos Images

You can introduce an image with voice recording.

### Voice record

#### 1 Install the Bluetooth headset.

Press the *UP* or *DOWN* arrow on the omni selector to highlight the  [Media] menu, then press the OK key to enter.

2

Alternatively, touch/select the [Media] Icon to open the menu.

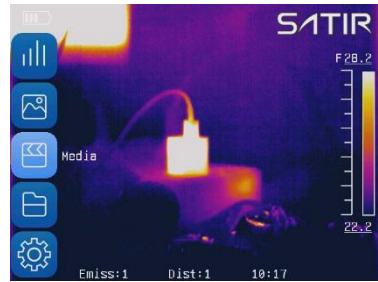

Press the *UP* or *DOWN* arrow on the omni selector to highlight  [Voice], then





3

press the OK key.

Alternatively, touch/select the [Voice] Icon to save the Image.



---

In the pop-up menu bar, touch/select the  icon. When  change into , it means the voice is being recorded. Touch/select the 

**4** icon again, stop the voice recording. Tap the [save] key to save the voice. Tap the [Play] to play the voice you just recorded. Tap the [close] you can exit the menu.



The storage capacity of the memory will not decrease when you attach voice comment to an image.

# Shoot

## Snapshot and Edit the image

### Snapshot/Edit

- 1 Press the [C] key or touch/select the **SATIR** icon.

Press the *UP* or *DOWN* arrow on the omni selector to highlight the  [Media] menu, then press the OK key

- 2 to enter.

Alternatively, touch/select the [Media] icon to open the menu.



- 3 Press the *UP* or *DOWN* arrow on the omni selector to highlight the  [Snapshot] and press the [OK] key then the image will be saved automatically.

Alternatively, touch/select the [Snapshot] icon to save image automatically.



Press the *UP* or *DOWN* arrow on the omni selector to highlight the  [Edit], then press the [OK] key to enter.

**4**





Alternatively, touch/select the [Edit] icon to open the menu.



In this menu, you can edit the image like adding the text or voice note.



### About the Media

	<b>Snapshot:</b> Select and press the <b>OK</b> key to capture the present image
	<b>Edit:</b> Edit the captured image
	<b>Voice:</b> Record voice for the image
	<b>Video:</b> Record a video
	<b>Replay:</b> Replay the record video

# Shoot

## Record/Replay the Video

### Record/Replay the Video

**1** Press the [C] key or touch/select the **SATIR** icon.

Press the *UP* or *DOWN* arrow on the omni selector to highlight the  [Media] menu, then press the OK key

**2** to enter.

Alternatively, touch/select the [Media] Icon to open the menu.

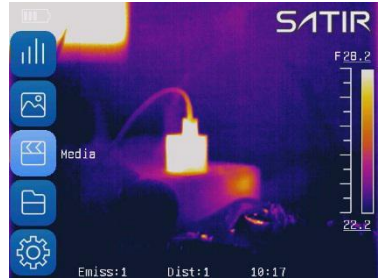

Press the *UP* or *DOWN* arrow on the omni selector to highlight the  [Video] and press the [OK] key to start recording the video.

**3** Alternatively, touch/select the [Video] Icon to start recording the video.



Highlight the  [Video Record] and press the OK key again to stop recording.

**4** Alternatively, touch/select the [Video] Icon again to stop recording the video.





Press the *UP* or *DOWN* arrow on the omni selector to highlight  [Replay] and press the [OK] key to replay the

**5** recorded video.







Alternatively, touch/select the [Replay] Icon again to replay the video.



**6** Press the [C] key to exit after replaying.



### About the Replay toolbar

	<b>Play:</b> Play or pause the playing
	<b>Stop:</b> Stop playing the video
	<b>Last:</b> Playing the last video
	<b>Next:</b> Playing the next video
	<b>Full Screen:</b> Playing the video full screen
	<b>Select File:</b> Select a video
	<b>Back:</b> Back to the [Media] menu

# Playback and Erase

## Open Images

You can view and analyze the recorded images on the LCD monitor.

## Open Images

**1** Press the [C] key or touch/select the **SATIR** icon.

**2** Press the *UP* or *DOWN* arrow on the omni selector to highlight the  [Media] menu, then press the *OK* key to enter.

Alternatively, touch/select the [Media] icon to open the menu.



**3** Press the *UP* or *DOWN* arrow on the omni selector to highlight the  [Edit], then press the *OK* key to enter. Alternatively, touch/select the [Edit] icon to open the menu.

Press *LEFT* or *RIGHT* arrow on the omni selector to select an image. Press *UP* or *Down* arrow on the omni selector to select a tool. Then press *OK* key to use the tool to edit the image.

Alternatively, use the touchscreen to edit the image.











You can analyze and attach voice memo to a recorded image when you open it.



### Photo edit sub menu description

	<b>Analysis</b> (Analysis tools can be used to analyze the heat images)
	<b>Delete</b> (Delete the currently selected picture)
	<b>Slideshow</b> (All current picture slideshow)
	<b>Full screen</b> (Full screen display picture)
	<b>Text Note</b> (Add text notes for the current picture)
	<b>Record</b> (Add voice notes to the current picture)

# Playback and Erase

## File Manager

### File manager

- 1 Press the [C] key or touch/select the **SATIR** icon.

Press the *UP* or *DOWN* arrow on the omni selector to highlight the  [File], then press the *OK* key to

- 2 enter.

Alternatively, touch/select the [File] icon to open the menu.







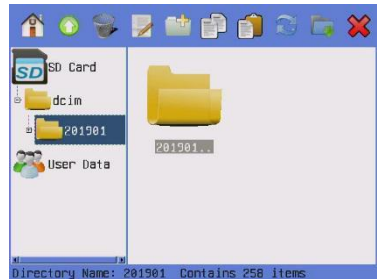





- 3 Press *UP* or *DOWN* arrow on the omni selector to highlight file or tool, press the [C] key to shift file to tool. Press the *OK* key to execute the operation on the chosen file.

Alternatively, use the touchscreen to use tool or open the file.





## About the File manager

	<b>Home</b> ( Enter the home directory )
	<b>Previous</b> ( Back to the parent directory )
	<b>Remove</b> ( Remove the file or directory )
	<b>Rename</b> ( Rename the file or folder )
	<b>New</b> ( Build a directory )
	<b>Copy</b> ( Copy the file )
	<b>Paste</b> ( Paste the file )
	<b>Refresh</b> (Refresh the file list)
	<b>Save Folder</b> (Setting the saving path)
	<b>Close</b> (Close file manager)

## Selecting the file path

---

**1** Press the [C] key or touch/select the  icon.

---

Press the *UP* or *DOWN* arrow on the omni selector to highlight the  [File], then

**2** press the *OK* key to enter.

Alternatively, touch/select the [File] icon to open the menu.



Press the *UP* or *DOWN* arrow on the omni selector to highlight the folder you want and press *OK*. Then press the *LEFT* or *RIGHT* arrow to select  icon.

**3**

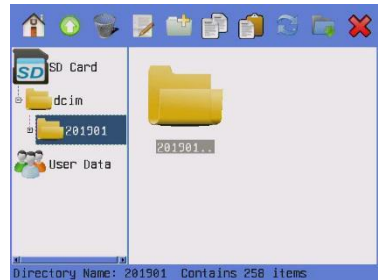

Press the *OK* key and all files will be saved in the file path.

Alternatively, use touchscreen to select the file path.

**4**

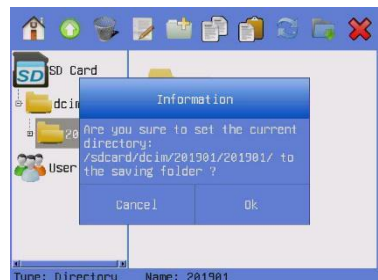

# Connection and Download

## Download the images

### Download the images

- 1 Open the USB / Video cover on the button of device.

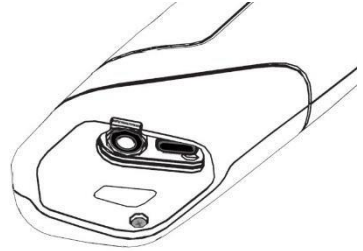

- 2 Use USB cable connect device to computer then modify device USB Mode to UDisk.



- 3 Copy images and videos to your computer.



# Connection and Download

## Connect to a video-compatible monitor

### Connect to a video-compatible monitor

A video-compatible monitor connected via the video cable (supplied) can be used to view and analyze images you shoot.

1

Attach video cable to the video out terminal on bottom of camera.

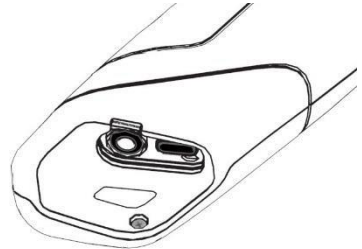

2

Plug the other end of the video cable to the video in jack on the monitor.

To the video in  
jack



3

You can select TV-Out mode, refer to P21.

After connecting via video cable, you can press *Up and Down* arrow Key at the same time to open video output, and press *Up and Down* arrow Key at the same time again to shut off the video output.



**P.s.**

Once you open the video output mode, the Display will stop working. When you shut off the video output, the Display will work again.





# Connection and Download

## Connect to a computer

### Connection

Connect the USB cable to the computer's USB port and the multi-functional dock's terminal.



- You do not need to turn off the computer or camera when making this connection.
- Please refer to your computer manual for information regarding the location of the USB port

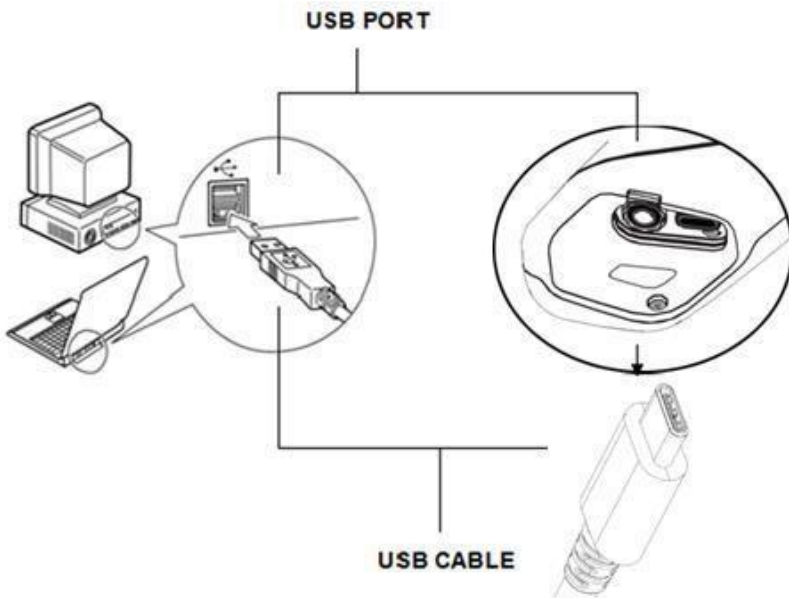

# Connection and Download

## Real-time transfer

### Real-time transfer

You can analyze and save the thermal video in computer directly via the USB by the optional real-time software.

- 1** Power on the camera.
- 2** Connect the camera and computer via USB cable.
- 3** The operating system will recognize the camera automatically.

Run the analysis software.

Meanwhile, please set the camera as below: [System setup]-[camera setup]-[USB type]-[USB real-time]. You can analyze the real-time video, and save it in your computer's disk.

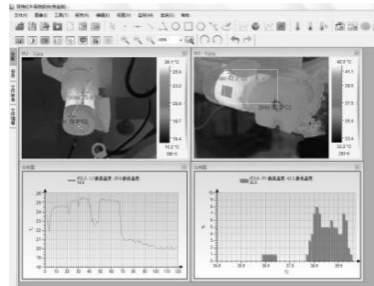

# Connection and Download

## Real-time transfer

### Troubles shooting

When you have any problems in the process of connecting the IR camera to a computer to use optional real-time software, check this first.

#### First, Check the Following

1. Does your computer comply with these requirements?  
Ensure the system has a built-in USB port.  
The USB interface is not supported for systems not complying with the above conditions.
2. Is the camera correctly connected to the computer?
3. Is the built-in battery charged sufficiently?

#### •If the Problem Is Not Mentioned Above

If the USB Driver is not correctly installed, it is possible that Windows is not recognizing the USB Driver. Please contact your motherboard's manufacturer for the latest driver.

The USB2.0 real-time transmission function may not properly work under some model of motherboard's chipset. In this case, connect the IR camera to another computer which is based on the chipset of Intel configuration or Nvidia configuration and try again.

# Connection and Download

## Use the Bluetooth headset

### Use the Bluetooth headset

Follow the steps to install the Bluetooth headset for the first time.

1	Set the camera as below : <b>[Setting]—[System]—[Bluetooth]</b> .
2	Long press the Bluetooth headset power button for about 10 seconds to power indicator flash the red and blue lights to <b>seek connecting state</b> for the Bluetooth headset. It lasts 120 seconds.
3	Tap <b>Search-Search</b> to search the Bluetooth headset, then tap <b>Bind</b> and input the PIN ( <b>0000</b> or <b>1234</b> ) to bind the Bluetooth headset. The power indicator begins to blink blue, if the headset is connecting to the camera. Tap <b>Connected Dev</b> to check the headset.
4	Once bound successfully, set the Bluetooth headset to <b>seeking connection state</b> , then go to <b>Paired Dev</b> to tap <b>Bind</b> and input the PIN to bind the headset.
5	Try again step 1 to 4 if fail to bind. If you want to release the Bluetooth headset after the binding is successful, Tap the <b>Connected Dev</b> to tap <b>delete</b> to release the headset.
6	Wear the headset, you can record the voice memos or play back the memos now.



\*Bluetooth headset is not the standard accessory. The picture is for reference and the sample is subject to the real product which you will receive.

# Troubles Shooting

Problem	Cause	Solution
Camera will not operate	Power is not turned on.	<ul style="list-style-type: none"><li>• Turn on the camera. See <i>Turning the Power On / Off</i> (p.12).</li></ul>
	Insufficient battery voltage.	<ul style="list-style-type: none"><li>• Fully charge the battery.</li></ul>
Camera will not record	Internal memory is full.	<ul style="list-style-type: none"><li>• If required, download the images to a computer and erase them to make some space.</li></ul>
Battery pack consumed quickly	Battery pack capacity reduced because of disuse for one year or more after being fully charged.	<ul style="list-style-type: none"><li>• Replace the battery pack with a new one.</li></ul>
	Battery life exceeded.	<ul style="list-style-type: none"><li>• Replace the battery pack with a new one.</li></ul>

# Appendix

## How to setup for optional Lens

---

There are optional lenses for D600 available, from telephoto lens to wide-angle lens.

If you install the optional lens, the camera will automatic match corresponding camera image mode, through the magnetic core on the lens and the internal sensor in the camera. During this period, the image will be automatically adjusted several times for clear display. There are 7°, 12° and 48° optional lenses.

---

# Appendix

## Attach Optional Lens

### Attach Optional Lens

Open the lens cover. Align the magnetic columns and the lens slots. Green to green, blue to blue and red to red. Please see the picture on the right.

**1**

**Notice :**  
The three round holes on the lens must be in the lower right corner as shown on the right, otherwise the lens cannot be assembled.

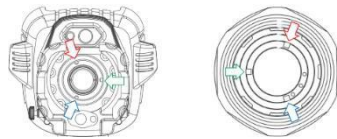

**2** Attach the lens. Insert the lens as shown in the figure.

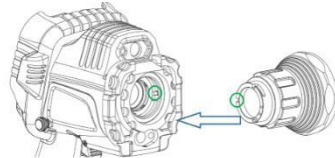

**3** After insert the lens, rotate the lens as shown in the figure.

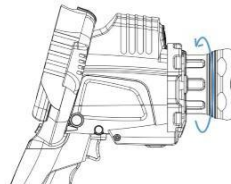



---

**4**

After the lens is installed, D600 will automatically identify lens parameters, so there is no need to set in D600. For example, when you install the 12° lens, the menu will change as shown in the picture.

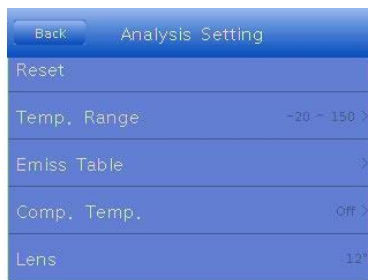

# Appendix

## Remove Optional Lens

### Remove Optional Lens

---

- 1** Rotate the lens according to the direction of the arrow on the right to remove the lens.

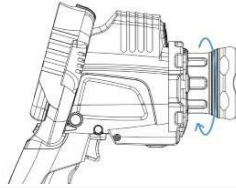

- 2** Pull out the lens.

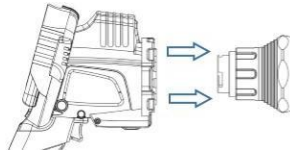

# Appendix

## Camera Care and Maintenance

Use the following procedures to clean the camera body, lens, LCD monitor and other parts.

<b>Camera Body</b>	<b>Wipe the body clean with soft cloth or eyeglass lens wiper.</b>
<b>Lens</b>	<b>First use a lens blower to remove dust and dirt, then remove any remaining dirt by wiping the lens lightly with soft cloth.</b> <ul style="list-style-type: none"><li>• <b>Never use synthetic cleaners on the camera body or lens.</b></li></ul>
<b>LCD Display</b>	<b>Use a lens blower brush to remove dust and dirt. If necessary, gently wipe the LCD Display with soft cloth or an eyeglass lens wiper to remove stubborn dirt.</b> <ul style="list-style-type: none"><li>• <b>Never rub or press forcefully on the LCD Display. These actions may damage it or lead to other problems.</b></li></ul>



Never use thinners, benzene, synthetic cleaners or water to clean the camera. These substances may distort or damage the equipment.

# Appendix

## Emissivity table

Material	Temperature ( °C)	Emissivity approximation
Metal		
Aluminum		
Polished aluminum	100	0.09
Commercial aluminum foil	100	0.09
Electrolytic chromeplate alumina	25 ~ 600	0.55
Mild alumina	25 ~ 600	0.10 ~ 0.20
Strong alumina	25 ~ 600	0.30 ~ 0.40
Brass		
Brass mirror (highly polished)	28	0.03
Brass oxide	200 ~ 600	0.61 ~ 0.59
Chrome		
Polished chrome	40 ~ 1090	0.08 ~ 0.36
Copper		
Copper mirror	100	0.05
Strong copper oxide	25	0.078
Cuprous oxide	800 ~ 1100	0.66 ~ 0.54
Liquid copper	1080 ~ 1280	0.16 ~ 0.13
Gold		
Gold mirror	230 ~ 630	0.02

# Appendix

## Emissivity table (continue)

Material	Temperature ( °C )	Emissivity approximation
Iron		
Polished cast iron	200	0.21
Processed cast iron	20	0.44
Polished tempered Iron	40 ~ 250	0.28
Polished steel ingot	770 ~ 1040	0.52 ~ 0.56
Raw welded steel	945 ~ 1100	0.52 ~ 0.61
Surface ferric oxide	20	0.69
Completely rusty surface	22	0.66
Rolled iron plate	100	0.74
Oxidized steel	198 ~ 600	0.64 ~ 0.78
Cast iron (Oxidizing at 600°C)	198 ~ 600	0.79
Steel (Oxidizing at 600°C)	125 ~ 520	0.78 ~ 0.82
Electrolytic ferric oxide	500 ~ 1200	0.85 ~ 0.89
Iron plate	925 ~ 1120	0.87 ~ 0.95
Cast iron, heavy ferric oxide	25	0.80
Tempered iron, ferric oxide	40 ~ 250	0.95
Melting surface	22	0.94
Melting cast iron	1300 ~ 1400	0.29
Melting mild steel	1600 ~ 1800	0.28
Liquid steel	1500 ~ 1650	0.42 ~ 0.53
Pure liquid iron	1515 ~ 1680	0.42 ~ 0.45

# Appendix

## Emissivity table (continue)

Material	Temperature ( °C )	Emissivity approximation
Lead		
Pure lead (Non-oxidization)	125 ~ 225	0.06 ~ 0.08
Mildly oxidized	25 ~300	0.20 ~ 0.45
Magnesium		
Magnesia	275 ~ 825	0.55 ~ 0.20
Magnesia	900 ~ 1670	0.20
Hg	0 ~ 100	0.90 ~ 0.12
Nickel		
Electroplate polishing	25	0.05
Electroplate	20	0.01
non-polishing		
Nickel wire	185 ~ 1010	0.09 ~ 0.19
Nickel plate	198 ~ 600	0.37 ~ 0.48
Nickel oxide	650 ~ 1255	0.59 ~ 0.86
Nickel alloy		
Nickel-chrome (heat-resistance) alloy wire (shining)	50 ~ 1000	0.65 ~ 0.79
Nickel-chrome alloy	50 ~ 1040	0.64 ~ 0.76
Nickel-chrome (heat resistance)	50 ~ 500	0.95 ~ 0.98
Nickel-silver alloy	100	0.14
Silver		
Polished silver	100	0.05

# Appendix

## Emissivity table (continue)

Material	Temperature ( °C )	Emissivity approximation
Stainless steel		
18-8	25	0.16
304(8Cr,18Ni)	215 ~ 490	0.44 ~ 0.36
310(25Cr,20Ni)	215 ~ 520	0.99 ~ 0.97
Tin		
Commercial tin plate	100	0.07
Strong oxidization	0 ~ 200	0.60
Zinc		
Oxidizing at 400°C	400	0.01
galvanized shining iron plate	28	0.23
Ash zinc oxide	25	0.28
Non-metal materials		
Brick	1100	0.75
Fire brick	1100	0.75
Graphite(lamp black)	96 ~ 225	0.95
Porcelain enamel (white)	18	0.90
Asphaltum	0 ~ 200	0.85
Glass (surface)	23	0.94
Heat-resistance glass	200 ~ 540	0.85 ~ 0.95
Calcimine	20	0.90
Oak	20	0.90

# Appendix

## Emissivity table (continue)

Material	Temperature ( °C )	Emissivity approximation
Carbon piece		0.85
Isolation piece		0.91 ~ 0.94
Sheet metal		0.88 ~ 0.90
Glass pipe		0.90
Loop type		0.87
Porcelain enamel products		0.90
Porcelain enamel designs		0.83 ~ 0.95
Solid materials		0.80 ~ 0.93
Ceramics (vase type)		0.90
Film		0.90 ~ 0.93
Mica		0.94 ~ 0.95
Flume mica		0.90 ~ 0.93
Glass		0.91 ~ 0.92
Semiconductor		0.80 ~ 0.90
Transistor (plastics sealed)		0.30 ~ 0.40
Transistor (metal) Diode		0.89 ~ 0.90
Transmitting loop		
Pulse transmission		0.91 ~ 0.92
Level chalkiness layer		0.88 ~ 0.93
Top loop		0.91 ~ 0.92



# Appendix

## Emissivity table (continue)

Material	Temperature ( °C)	Emissivity approximation
Electric materials		
Epoxy glass plate		0.86
Epoxy hydroxybenzene plate		0.80
Gilded sheet copper		0.30
Solder-coated copper		0.35
Tin-coated lead wire		0.28
Brass wires		0.87 ~ 0.88
Block talcum terminal		0.87

# Specification

All data is based on SATIR's testing standard. Subject to change without notice.

Type	D600
<b>Image performance</b>	
FOV/Min. focus distance	24° x18°/0.25m
Spatial resolution	0.65 mrad
Thermal sensitivity	0.03°C@30°C
Detector type	UFPA
Resolution	640x480
Spectral range	7.5-14um
Focus	Motor/Auto/Manual
<b>Image presentation</b>	
Image mode	IR/CCD/Duo-vision//Duo-vision Plus
LCD Display	3.5" Capacitive touch screen
Visible pixels	High definition CCD , 5million pixels
Video output	NTSC (60Hz) or PAL (50Hz) composite video
<b>Temperature measurement</b>	
Measurement range	-20°C ~ +600°C , up to +1500°C (optional)
Accuracy	±2° or ±2% of readings
Measurement mode	8 movable spots, auto hot/cold spot, profile, 5 area boxes, isotherm, line
Correction	Emissivity, ambient temperature, distance, relative humidity, reflected temperature
Alarm	Yes

<b>Image storage</b>	
Type	32GB and 64GB MicroSD are optional
Image format	IR Image: .JPG(thermal/Visual) CCD Image: .JPG
Video format	.MPEG
Annotation	Voice, note annotation
<b>Power system</b>	
Battery type	Built-in rechargeable lithium-ion battery (Non-Volatile Memory)
Charge interface	Type-C
Battery operating time	8 hours
Power manage	Auto shut off / Sleep mode
<b>Environment specification</b>	
Operating temperature range	-20°C to +50°C
Storage temperature range	-40°C to +70°C
Humidity	10% to 95%, non-condensing
Encapsulation	IP54
Shock Resistance	25G (During Operation)
Vibration	2G (During Operation)
Drop resistance	2 meter
<b>Physical characteristic</b>	
Size	232mm×115mm×168mm
Weight	Less than 900g
Tripod mounting	1/4" _20

<b>Additional features</b>	
Illuminator	Yes
Laser pointer	Yes
Video record	Yes
Ports	USB port , Analog video output
Bluetooth	Yes
Available optional lenses	7°, 12°, 48°

Please download quick user guide, user manual and SatlrReport Software from SATIR website if you need.

Download Link: [www.satir.com](http://www.satir.com)

### **Manufacturer information**

**Manufacturer:** SATIR Europe(Ireland) Co.,Ltd.

**Factory address:** Marleys Business Park, Marleys Lane, Drogheda  
Co.Louth, A92 PX6P, Ireland

**URL:** [www.satir.com](http://www.satir.com)

**E-mail:** [enquiry@satir.com](mailto:enquiry@satir.com)  
[service@satir.com](mailto:service@satir.com)

**Technical enquiry Tel:** 00353 (0) 41 9844371

**Sales enquiry Tel:** 00353 (0) 41 9846786