

G96 Plus

User's manual



Trademark Acknowledgments

- SATIR is a trademark of SATIR Europe Ireland Ltd.
- Other names and products not mentioned above may be registered trademarks or trademarks of their respective companies.

1

About this IR Camera User Guide

Symbols Used



This mark denotes issues that may affect the IR camera's operation.



This mark denotes additional topics that complement the basic operation procedures.

- **What do the icons listed in the Camera User Guide mean?**
Information displayed on the LCD Monitor (p.20)

Thumb Index

Introduction of camera components and battery loading.

Preparing the IR Camera

Describes basic functions, learning how to turn on/off the IR camera and work with the control panel and LCD monitor.

Basic function

Describes working with the camera, from each analysis settings tousing the camera'svarious analysis tools.

Shooting

Explains how toreview recorded images, erase images and playback voice memos.

Playback and erase

Explains how totransfer images or video to a computer.

Connection and download

You must read this section before connecting your camera to a computer.

Table of Contents

Functions and operations tables

Read This First.....	5
Component Guide.....	10
Front View.....	10
Back View.....	11
Controls.....	12
Preparing the IR Camera.....	13
Charging the Battery Pack.....	13
Installing the Battery Pack/ SD Card.....	14
Turning the Power On/ Off.....	16
Connecting the Remote Controller.....	17
Using an External Mounted Shooting lamp.....	18
Using a Headset.....	19
Checking the Information.....	20
Setting the Date/ Time.....	22
Local Settings.....	23
Basic Functions.....	25
Using the LCD Monitor.....	25
Selecting Menus and Settings.....	27
Resetting the Setting to Default.....	29
Shooting.....	30
IR Camera Adjustment.....	30
Auto Focus.....	30
Manual Focus.....	31
Display Modes.....	32
DuoVisionDisplay modes.....	32
DuoVision.....	33
Image Adjustment.....	35
Auto Adjust.....	35
Manual Adjustment.....	36
Palette settings.....	37
Image Settings.....	38
Measurement Range.....	40
Freezing/ Activating an Image.....	41
Fulfill the Analysis Function.....	44
Object/Global Settings.....	44

Analysis Settings.....	45
Setting Analysis Tools.....	47
Spot Analysis.....	47
Area Analysis.....	49
Profile Analysis.....	51
Isothermal Analysis.....	52
Remove Analysis Tools.....	53
Saving Image.....	54
Attaching Memos to Images.....	55
Voice Recording.....	55
Playback and Erase.....	56
Opening Images.....	56
Playback Memos.....	59
Erase Images.....	60
Download the Images.....	61
Download via SD Card.....	61
Connecting and Download.....	62
Connecting to a Monitor.....	62
Connecting to a computer.....	63
Connecting to a computer.....	63
Installing Driver.....	64
Transfer Video via USB.....	66
Troubles shooting.....	67
Using the blue tooth headset.....	68
Using GPS.....	69
Troubles Shooting.....	70
Appendix.....	71
Using the optional lens.....	71
Camera Care and Maintenance.....	73
Emissivity table.....	74
Specifications.....	80

Read This First

Please Read

Test Shots

Before you try to shoot important subjects, we highly recommend that you shoot several trial images to confirm that the IR camera is operating and being operated correctly.

Please note that SAT, its subsidiaries and affiliates, and its distributors are not liable for any consequential damages arising from any malfunction of an IR camera or accessory that results in the failure of an image to be recorded or to be recorded in a format that is machine readable.

Warning Against Copyright Infringement



Safety Precautions

Before using the camera, please ensure that you read and understand the safety precautions described below. Always ensure that the IR camera is operated correctly.

The safety precautions noted on the following pages are intended to instruct you in the safe and correct operation of the IR camera and its accessories to prevent injuries or damage to yourself, other persons and equipment.

Warnings

Read on to learn about using IR camera properly.

Avoid damaging eyesight

Warning: Do not trigger the laser pointer in human or animal eyes. Exposure to the laser produced by the laser pointer may damage eyesight.

Do not disassemble

Do not attempt to disassemble or alter any part of the equipment that is not expressly described this guide

Stop operating immediately if it emits smoke or noxious fumes

Failure to do so may result in fire or electrical shock. Immediately turn the IR camera's power off, remove the IR camera battery or unplug the power cord from the power outlet. Confirm that smoke and fume emissions have ceased.

Stop operating immediately if it is dropped or the casing is damaged

Failure to do so may result in fire or electrical shock. Immediately turn the IR camera's power off, remove the IR camera battery or unplug the power cord from the power outlet.

Do not use substances containing alcohol, benzene, thinners or other flammable substances to clean or maintain the IR camera

The use of these substances may lead to fire.

Remove the power cord on a regular periodic basis and wipe away the dust and dirt that collects on the plug, the exterior of the power outlet and the surrounding area

In dust, humid or greasy environments, the dust that collects around the plug over long periods of time may become saturated with humidity and short-circuit, leading to fire.

Do not handle the power cord if your hands are wet

Handling it with wet hands may lead to electrical shock. When unplugging the cord, ensure that you hold the solid portion of the plug. Pulling on the flexible portion of the cord may damage or expose the wire and insulation, creating the potential for fires and electrical shocks.

Do not cut, alter or place heavy items on the power adapter cord

Any of these actions may cause an electrical short circuit, which may lead to fire or electrical shock.

Use only the recommended power accessories

Use of power sources not expressly recommended for this IR camera may lead to overheating, distortion of the IR camera, fire, electrical shock or other hazards.

Do not place the batteries near a heat source or expose them to directly to flame or heat

Neither should you immerse them in water. Such exposure may damage the batteries and lead to the leakage of corrosive liquids, fire, electrical shock, explosion or serious injury.

Do not attempt to disassemble, alter or apply heat to the batteries

This is serious risk of injury due to an explosion. Immediately flush with water any area of the body, including the eyes and mouth, or clothing, that comes into contact with the inner contents of a battery. If the eyes or mouth contact these substances, immediately flush with water and seek medical assistance.

Avoid dropping or subjecting the batteries to severe impacts that could damage the casings

It could lead to leakage and injury.

Do not short-circuit the battery terminals with metallic objects, such as key holders

It could lead to overheating, burns and other injuries.

Before you discard a battery, cover the terminal with tape or other insulators to prevent direct contact with other objects

Contact with the metallic components of other materials in waste containers may lead to fire or explosions. Discard the batteries in specialized waste facilities if available in your area.

Use only recommended batteries and accessories

Using of batteries not expressly recommended for this equipment may cause explosions or leaks, resulting in fire, injury and damage to the surroundings.

Disconnect the compact power adapter from both the IR camera and power outlet after recharging and when the IR camera is not in use to avoid fires and other hazards

Continuous use over a long period of time may cause the unit to overheat and distort, resulting in fire.

Do not use the battery charger or compact power adapter if the cable or plug is damaged, or if the plug is not fully inserted into the power outlet

The battery charger varies according to region.

Exercise due caution when screwing on the separately sold tele-lens, close-up lens

If the lens is loosened and fallen off, the glass shards may cause an injury.

If your camera is used for prolong periods, the IR camera body may become warm

Please take care when operating the IR camera for an extended period as your hands may experience a burning sensation.

Prevent Malfunction

Read on to learn about preventing malfunction of IR camera

Avoid damaging the detector of the IR camera

Warning: Do not aim the IR camera directly into the sun or at other intense heat source which could damage the detector of the IR camera.

Avoid Condensation Related Problems

Moving the IR camera rapidly between hot and cold temperatures may cause condensation (water droplets) on its external and internal surfaces.

You can avoid this by placing the IR camera in the plastic case (bundle) and letting it adjust to temperature changes slowly before removing it from the case.

If Condensation Forms Inside the IR Camera

Stop using the camera immediately if you detect condensation. Continue to use may damage the IR camera. Remove the PC card, and battery or a household power source, from the IR camera and wait until moisture evaporates completely before resuming use.

Extended Storage

When not using the IR camera for extended periods of time, remove the battery from the IR camera or battery charger and store the IR camera in a safe place. Storing the IR camera for extended periods with battery installed will run down the battery.

Right Reserved

SAT reserves the right to change the functions and configurations of our products without prior notice.

Component Guide

Front View

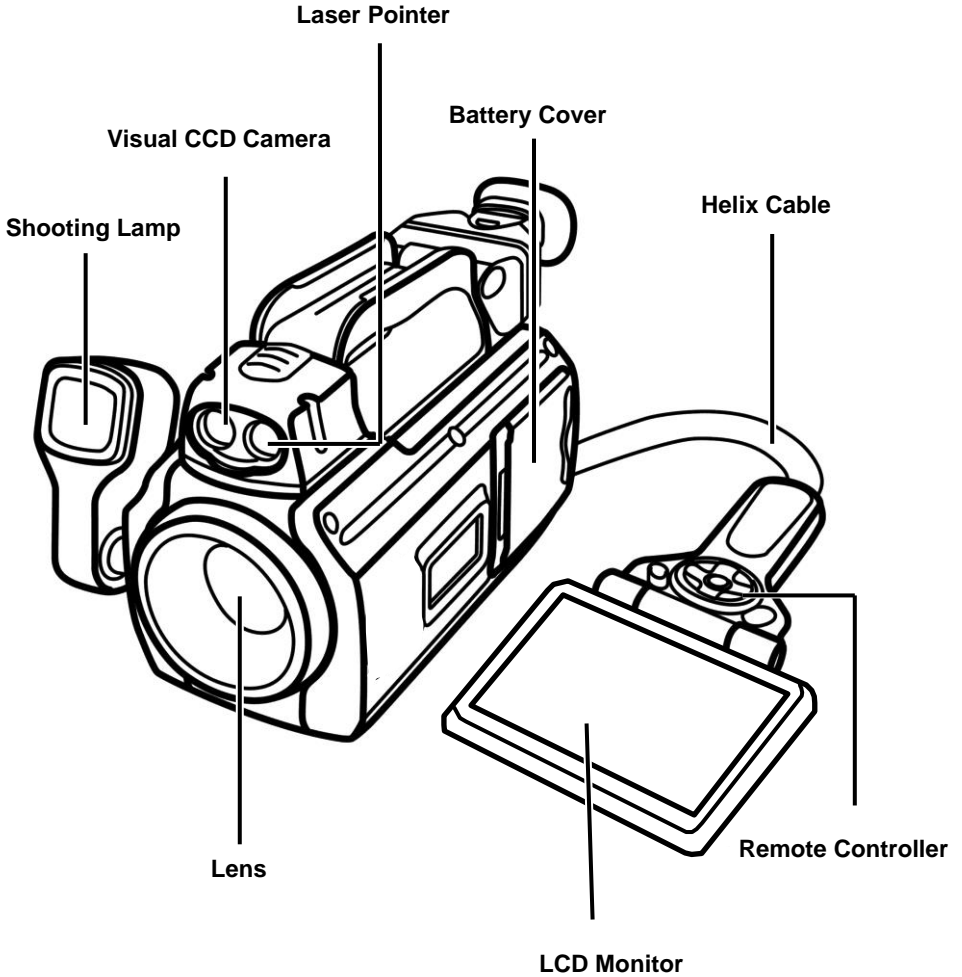

Component Guide

Back / Bottom View

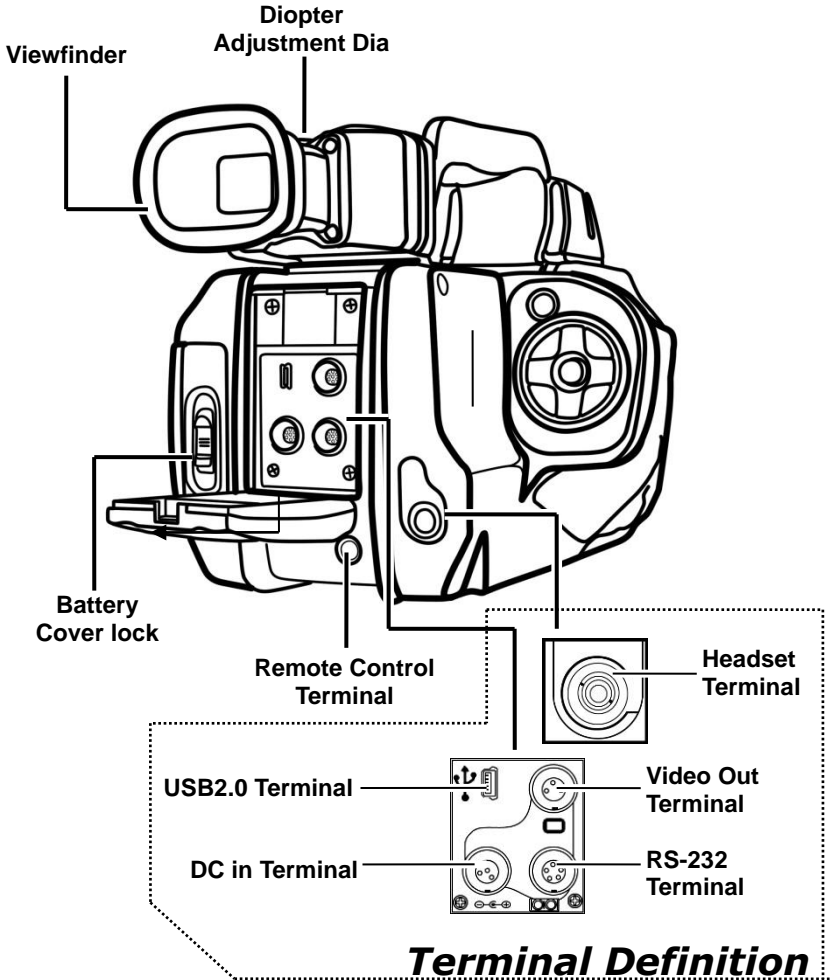

Component Guide

Controls

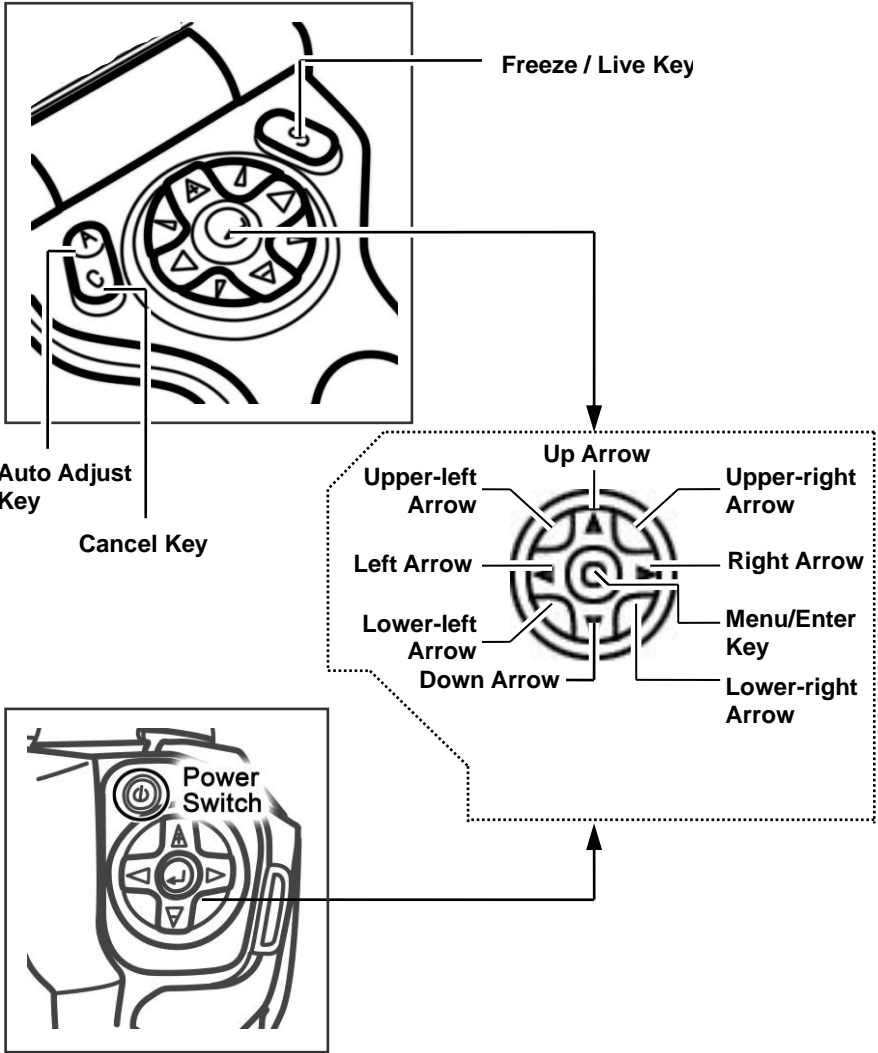

Preparing the IR Camera

Charging the Battery Pack

Follow the steps below to charge the battery pack for the first time and subsequently when the low battery icon appears on the LCD Display.

1

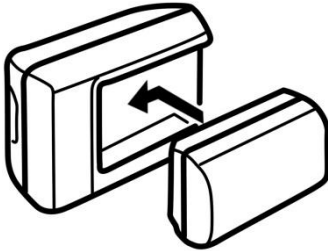

Align the edge of the battery pack with the line on the battery, then insert the battery in the direction of the arrow.

2

Attach the power cord to the battery charger and plug the other end into a power outlet.

- After charging, unplug the battery charger and remove the battery pack.



- This is a lithium ion battery pack so there is no need to discharge it completely before recharging. It can be recharged at any time. However, since the maximum number of charge cycle is approximately 300 (battery life), you are recommended to only charge the battery pack after having discharge it completely to prolong battery life.
- Charging times will vary according to the surrounding humidity and battery pack charge state.

Preparing the IR Camera

Installing the Battery Pack / SD Card

Install Battery Pack and the SD card (supplied) into the camera as follows.

 Charge the battery pack before using it for the first time.

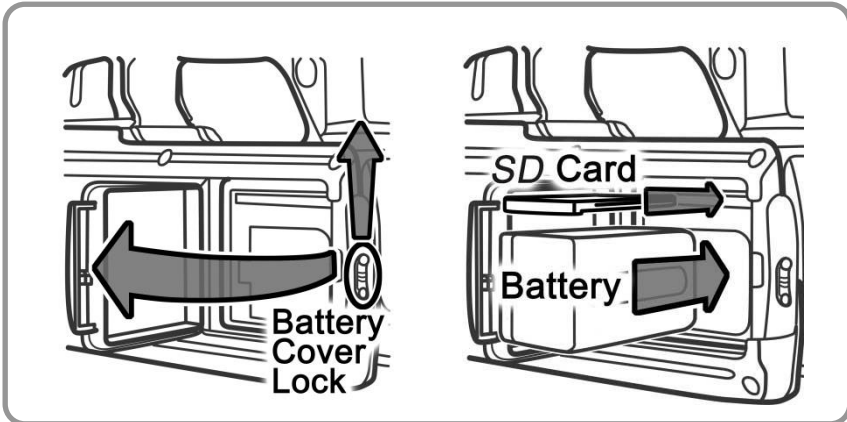

1 Check that the power is off and slide the battery cover lock in the direction of the arrow, the battery cover opens automatically.

2 Insert the battery pack.

- The battery terminal side should face leftward.
- Insert the battery pack all the way in until the battery lock clicks. To remove the battery pack, push the battery lock.

3 Insert the SD card.

- The label side of the SD card should face the battery
- To remove the SD card, push the SD card.

4 Close the SD card/battery cover.





- Remove the battery pack when the camera is not in use.
- You must format the SD card in FAT32 format. Otherwise, the IR camera may not recognize the SD card.



Battery Status Symbols

The following icons indicate the battery status on the LCD screen.

	Sufficient battery charge
	Low battery
	Replace or recharge battery

Preparing the IR Camera

Turning the Power On / Off

The power indicator remains lit while the power of the camera is on.

Powering the IR camera

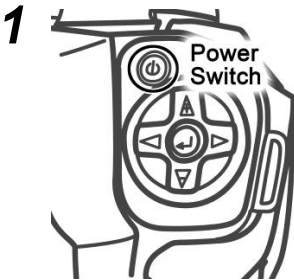

Press and hold the power switch for 3 seconds.

- The power indicator lights green.
- Connect the remote controller if needed.

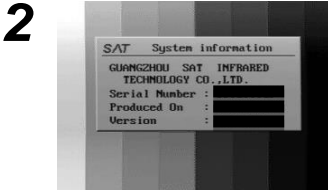

After a while, a startup image will appear on the screen.

Turning the Power Off

- 1** Hold the power switch for 3 seconds.
- The power indicator goes off.

Preparing the IR Camera

Connecting the Remote Controller

The detachable remote controller, with LCD display and all necessary control buttons can be connected to the camera body. You can view, capture and analyze images while the IR camera is positioned in hard-to-reach areas.

1 Turn off the IR camera.

2

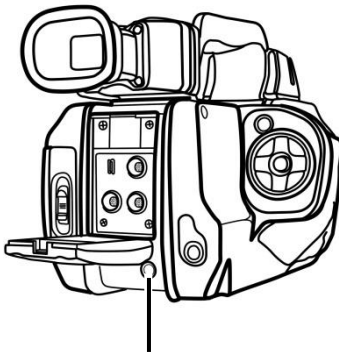

Remote control terminal

Attach the helix cable of the remote controller to the remote control terminal on the camera body.

3 Turn on the IR camera.



You can implement all the functions of the IR camera through the remote controller.

Preparing the IR Camera

Using an Externally Mounted Shooting Lamp

The shooting lamp (supplied) can be connected to the camera to illuminate the dark areas. You can always produce clear, high-quality visual images to do document of your inspections.

1 Turn off the IR camera.

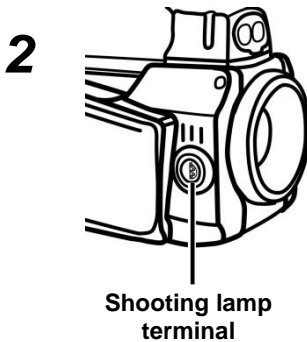

Attach the shooting lamp to the shooting lamp terminal on the camera body.

3 Turn on the IR camera.

4 Select [Setup]–[Camera]–[Camera Setup] to turn on the illuminator.



If you use the optional lens when the shooting lamp is attached, a portion of the visual image will be blocked by the optional lens and will appear dark.

Preparing the IR Camera

Using a Headset

The headset (supplied) can be connected to the camera to record and replay voice comment. You can save an image with voice comment.

1 Turn off the IR camera.

2



Attach the cable of the headset to the headset terminal the camera body.

3 Turn on the IR camera.

Preparing the IR Camera

Checking the Information on the LCD Monitor

The LCD monitor has a field of vision of 100% of the actual shooting image.

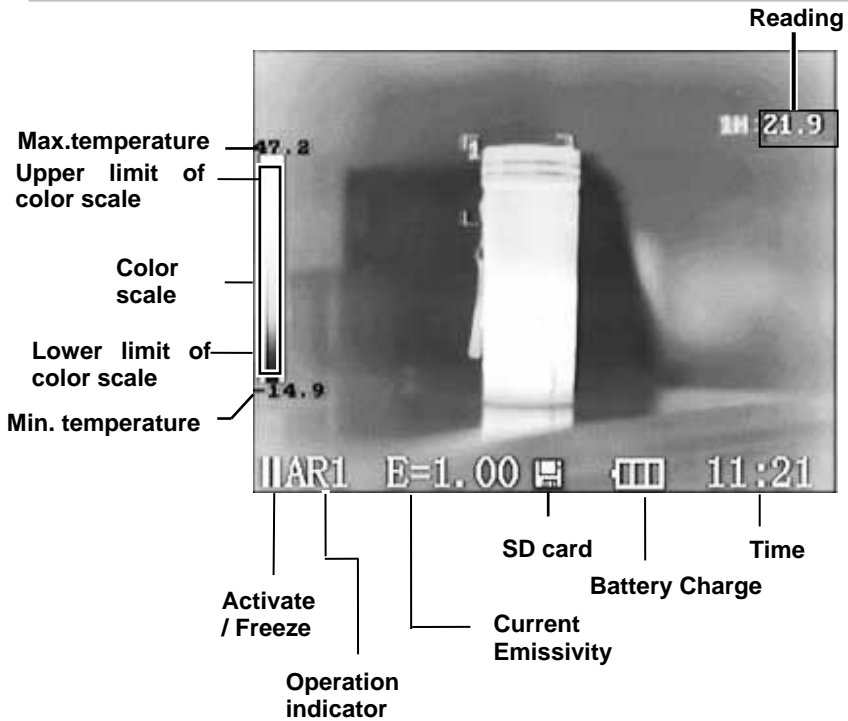

The following displays in information view.

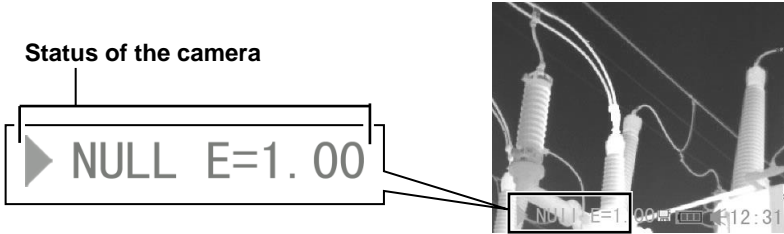

About the operation indicator

The operation indicator shows the current operation status of the camera.



Status of the camera	Menu	Represents the menu mode.
	Null	Represents the non-menu mode and no analysis tools is selected.
	*SP1...9	Represents the current analysis tool is spot 1 or spot 2... or spot 9.
	CAP.	Represents the current analysis tool is auto-tracking spot.
	*AR1...5	Represents the current analysis tool is area 1 or area 2... or area5.
	*PRO.	Represents the current analysis tool is profile.
	*ISO.	Represents the current analysis tool is isotherm analysis.
	E	Current Emissivity value
		SD card has been inserted.
		Bluetooth headset has been paired.

Before you make any further operation, please enter [Null] mode.



How to enter [Null] mode:

Press the **cancel** key repeatedly until see the message of null in the operation indicator.

Preparing the IR Camera

Setting the date and time

You need to set the Data / Time when the IR camera is turned on for the first time.

1 Make sure that the IR camera is in null mode.

2 Press the **MENU/ENTER** key, then press the **LEFT** or **RIGHT** arrow on the omni selector to select the **[Setup]** menu.

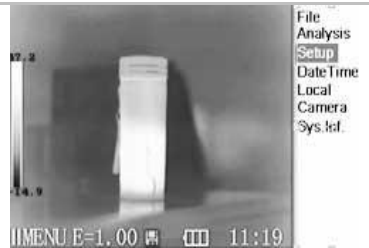

3 Press the **UP** or **DOWN** arrow on the omni selector to select **[Date Time]** then press the **MENU/ENTER** key.

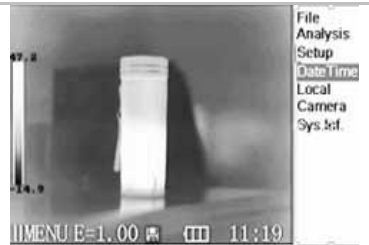

4 Setting Date and Time

- Press the **UP** or **DOWN** arrow on the omni selector to select a item to change.
- Press the **LEFT** or **RIGHT** arrow on the omni selector to set the values.



5 After adjusting the settings, press the **MENU/ENTER** key to save changes, or press the **C** key to go back to upper menu without saving.

Preparing the IR Camera

Local Settings

In this menu item, you can display style of the built-in menu system.

1 Make sure that the IR camera is in null mode.(p.21)

2 Press the **MENU/ENTER** key, then press the **LEFT** or **RIGHT** arrow on the omni selector to select the **[Setup]** menu.

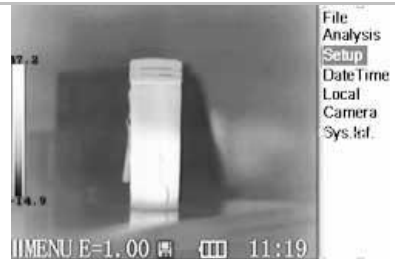

3 Press the **UP** or **DOWN** arrow on the omniselector to select **[Local]** then press the **MENU/ENTER** key.

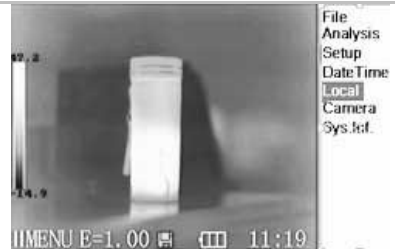

4 Local Setup.

- Press the **UP** or **DOWN** arrow on the omni selector to select a field to change.
- Press the **LEFT** or **RIGHT** arrow on the omni selector to set the values.



5 After adjusting the settings, press the **Menu/ Enter** key to save changes, or press the **C** key to exit without saving.



About the local settings

Language	Selects the language of the menus and messages.
Video output	Sets the format of the video output of the camera. PAL or NTSC.
Temp unit	Sets the format of the displayed temperature unit of the camera. °C or °F.
Distance unit	Sets the format of the displayed distance unit of the camera. Meter or Foot.

Basic Functions

Using the LCD Monitor / Viewfinder

Using the LCD Monitor

If you wish to use the LCD monitor for shooting, playing back thermal images and adjusting menu settings, follow the instruction below.

1

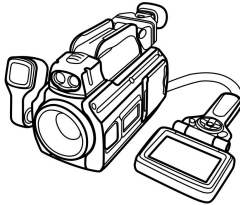

Attach the remote controller to the camera body.

2

Aim the IR camera at the subject.



Do remember to make the subject in center of the image that is shown on the LCD monitor (or the viewfinder).



The viewfinder will shut off when the remote controller connects to the camera body.

Using the Viewfinder

If you cannot view the screen clearly when the surrounding light is too bright, you can use the viewfinder.

1 Disassemble the remote controller.

2

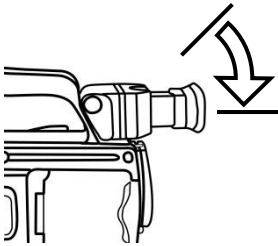

Adjust the angle of the viewfinder.

3

Aim the IR camera at the subject.



You can use the Diopter Adjustment Dia to suit your eyesight.

Diopter Adjustment Dia

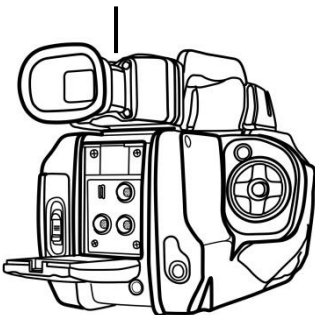

Basic Functions

Selecting Menus and Settings

You can select the settings by pressing the **MENU/KEY** key.



- 1 Press the **MENU / ENTER** key.
- 2 Press the **LEFT** or **RIGHT** arrow on the omni selector.
- 3 Press the **UP** or **DOWN** arrow on the omni selector.
- 4 Press the **MENU / ENTER** button.

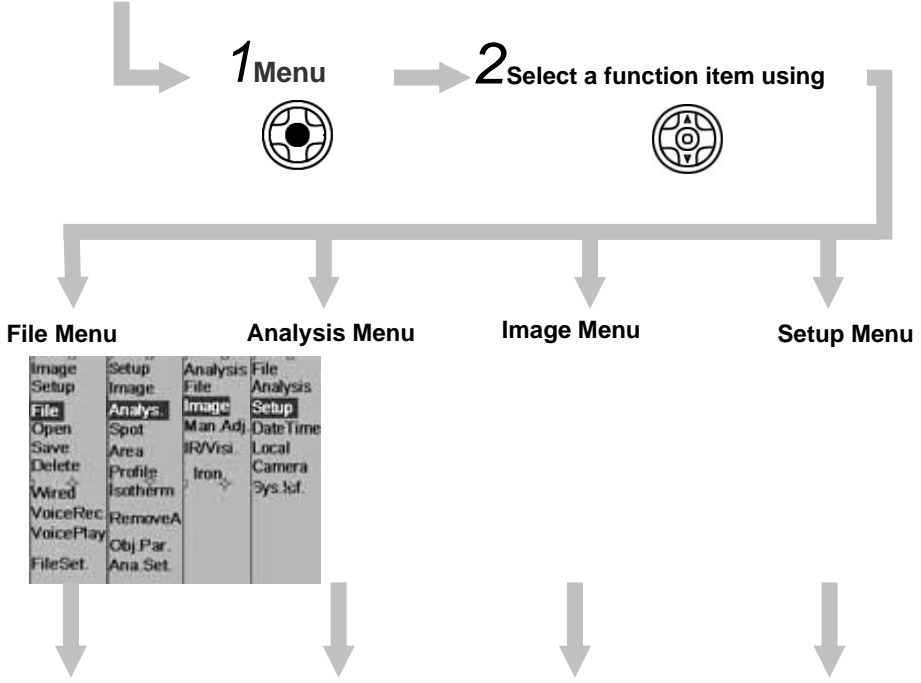

3 Select setting contents using

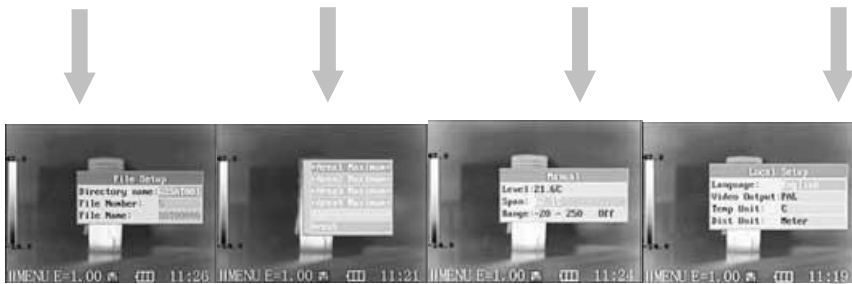
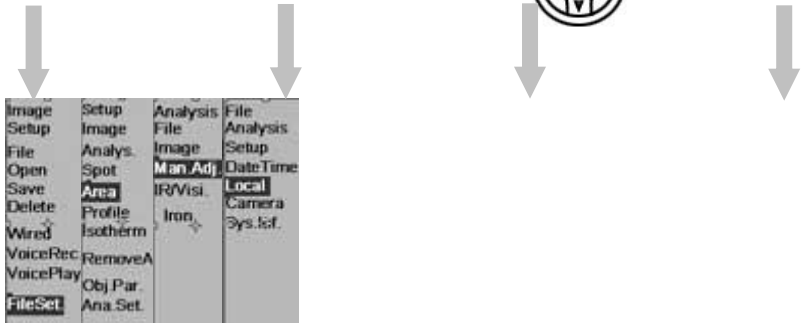

4 Change the settings using

Exit

Basic Functions

Resetting the Settings to Default

You can reset the menu and button operation settings to default.

1

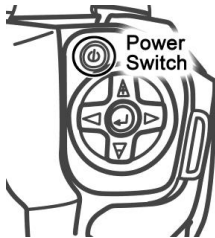

Turn off the IR camera.(p.16)

2



Press and hold the power switch and C key for seconds.



The data in storage will not be deleted when you reset the menu and button operation settings to default.

Shooting

IR Camera Adjustment

Focus Adjustment

Auto focus

1 Aim the IR camera at the subject.

-  Do remember to make the subject in center of the image that is shown on the LCD monitor (or in the viewfinder).



2 Press the A key and the C key on the IR camera body or remote controller.

-  You can stop auto focusing by pressing any key.

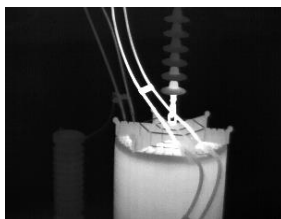

Shooting Problem Subjects for the Autofocus

The autofocus may not work well on the following types of subjects:

- Subjects with extremely low contrast to the surroundings
- Subjects mixing with close and far objects
- Subjects that are moving quickly
- Subjects with horizontal stripes

To Shoot these objects, first aim the camera at an object at a similar distance, then recompose the image with the desired object. You may also use manual focus.

Manual focus

1 Check that the IR camera is in null mode.

2



Aim the IR camera at the subject.

3

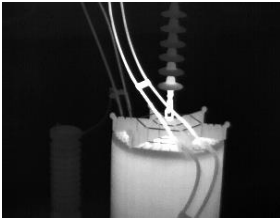

Hold the **UP** arrow or **DOWN** arrow on the omni selector on the camera body or removable handle until the camera focuses on the subject.



You can only focus manually in null status. Press **C** key to remove all the analysis tool if you add any of it. A **[NULL]** will appear on the operation indicator when the IR camera is in null status (p.21).

Shooting

IR Camera Adjustment

Duo-Vision Display modes

Thermal, Visual and Duo-Vision image display

This IR camera records visual images with its built-in digital camera. You can capture a visual image as a reference to the thermal image.

- 1 Press the **MENU/ENTER** key then press the **LEFT** or **RIGHT** arrow on the omni selector to select the **[Image]** menu.



- 2 Press the **UP** or **DOWN** arrow on the omni selector to select the **[IR/Visible]** menu.



- 3 **IR/Visible Setup**

- Press the **UP** or **DOWN** arrow on the omni selector to select an item to change.
- Press the **LEFT** or **RIGHT** arrow on the omni selector to set the values.



- 4 Press **UP** or **DOWN** arrow on the omni selector to select **[Mode]**, and press **LEFT** or **RIGHT** to select a display mode, then press **MENU/ENTER** key.

Shooting

IR Camera Adjustment



In **DuoVision** display mode, you can see the thermal images “fuse” into the visible images.



IR only

In this mode, you can use the analysis tools to analyze the target. But what you see is the image with pseudo color.

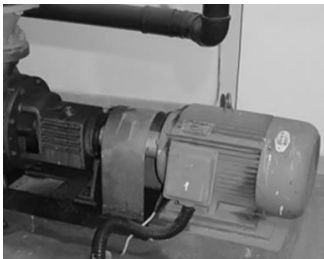

Vision Only

In this mode , you can see the image with full color. But you can not use any analysis tools to analyze the target.

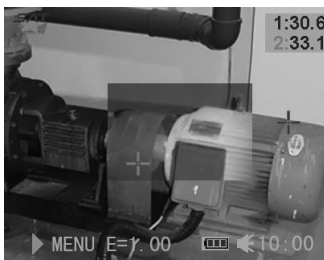

Duo Vision

In this mode, you can see the background image is fullcolor visible image. And the thermal image “fuses” on it in the center square. At the same time you can use any analysis tools to analyze the target.



In **DuoVision** display mode, you can move the fusion area via the combination keys.

Moving the fusion square

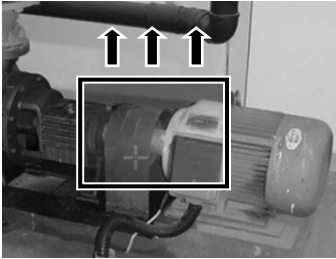

Move the area up
C + UP

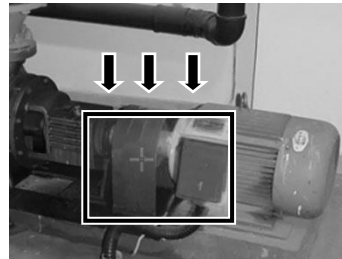

Move the area down
C + DOWN



Move the area left
C + LEFT

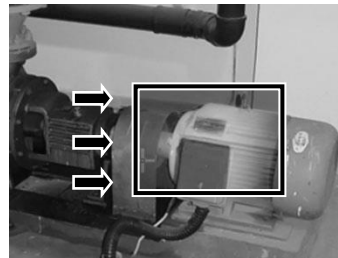

Move the area right
C + RIGHT



About the IR/Visible settings

IR
Percentage

Sets the ratio of IR images and Visual images. The value is from 1% to 100%.

The items above are activated only in [Duo-Vision] mode.

Shooting

IR Camera Adjustment

Image adjustment

You can adjust the Level (brightness) and Span (contrast) of the image captured by IR camera, manually or automatically.

Auto adjust

The IR camera will automatically adjust the brightness and / or contrast and calibrate when you press the **A** key for the first time. If you press **A** key a second time in 15 seconds, the camera will only adjust brightness and / or contrast.



You can define the adjustment mode, p.39.

Shooting

IR Camera Adjustment

Manual adjust

You can adjust the Level and Span of the image manually in the built-in menu system or by pressing arrows on the omni selector. Press **UPPER-LEFT** or **LOWER-LEFT** arrow to change the span, and press **UPPER-RIGHT** or **LOWER-RIGHT** arrow to change the level.

Manual adjust in the menu

- 1 Press the **MENU/ENTER** key then press the **LEFT** or **RIGHT** arrow on the omni selector to select the [Image] menu.

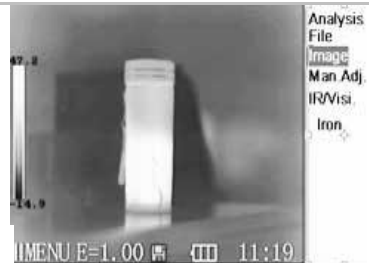

- 2 Press the **UP** or **DOWN** arrow on the omni selector to select the [Man Adj.] menu.

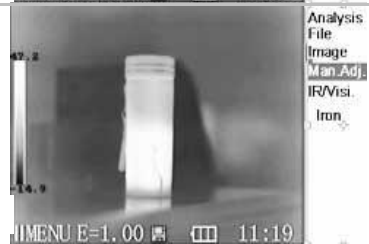

- 3 **Setting Level and Span.**

- Press the **UP** or **DOWN** arrow on the omni selector to select an item to change.
- Press the **RIGHT** or **LEFT** arrow on the omni selector to set the values.



- 4 After this operation, press the **MENU/ENTER** key to save changes, or press the **C** key to go back to the upper menu without saving.

Shooting

IR Camera Adjustment

Palette settings

- 1 Press the **MENU/ENTER** key, then press the **LEFT** or **RIGHT** arrow on the omni selector to select the [Image] menu.

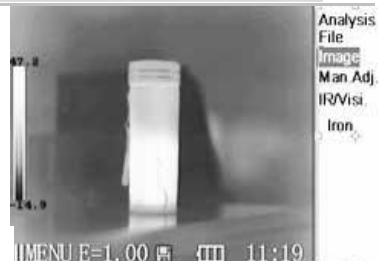

- 2 Press the **UP** or **DOWN** arrow on the omni selector to select the [Iron], press the **LEFT** or **RIGHT** arrow to choose the palette.

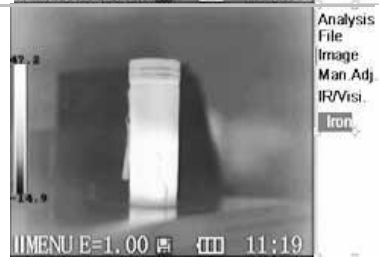

- 3 After this operation, press the **MENU/ENTER** key to save changes, or press the **C** key close the menu without saving.



The camera provides 6 kinds of palettes: Iron, Iron inverted, Rainbow, Feather, Grey and Grey inverted.

Shooting

IR Camera Adjustment

Image settings

- 1 Press the **MENU/ENTER** key, then press the **LEFT** or **RIGHT** arrow on the omni selector to select the [Setup] menu.

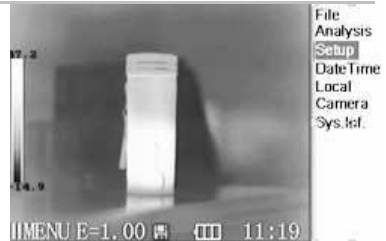

- 3 Press the **UP** or **DOWN** arrow on the omni selector to select [Camera], then press the **MENU/ENTER** key.



- 4 **Set the Image Settings.**
 - Press the **UP** or **DOWN** arrow on the omni selector to select an item to change.
 - Press the **RIGHT** or **LEFT** arrow on the omni selector to set the values.



- 5 After this operation, press the **MENU/ENTER** key to save changes, or press the **C** key to go back to the upper menu without saving.



About the Image Settings

Auto adjust	Sets the function of A key.	
	Level and Span	The camera will automatically adjust the level (brightness) and span (contrast) of the image to the optimum setting.
	Level	The camera will automatically adjust the level (brightness) of the image.
	Span	The camera will automatically adjust the span (contrast) of the image.
Continuous adj	Sets whether or not the brightness and contrast of the the image shown on the screen are adjusted automatically	
	Level and span	The brightness and contrast is adjusted automatically.
	Level	The brightness is adjusted automatically.
	None	The brightness and contrast will not be adjusted automatically.
Shutter period	Sets the period of auto-adjusting.	
LCD Display	Sets the period of shutting down the LCD Display.	
Shut Down	Sets the perid of shutting down the camera.	
Laser Adjust	Adjusts the Laser point in the LCD displayer.	
Menu Style	Sets the menu style.	

Shooting

IR Camera Adjustment

Measurement range

Follow the below steps to change the measurement range.

- 1 Press the **MENU/ENTER** key, then press the **LEFT** or **RIGHT** arrow on the omni selector to select the [Image] menu.



- 2 Press **UP** or **DOWN** arrow on the omni selector to select [Man Adj.], then press **MENU/ENTER** key.



- 3 **Selecting measurement range for different lens.**

- After selecting the [Range] field, press **UP** and **DOWN** arrow on the omni selector **at the same** time to change the measurement range for different lens(p.71).



- 4 After this operation, press the **MENU/ENTER** key to save the changes or press the **C** key to go back to the upper menu without saving.

Shooting

IR Camera Adjustment

Freezing / Activating an image

You can activate / freeze a thermal image by pressing the **S** key on the keypad.

1 Check that the IR camera is in null mode.(p.21)

2 Press the **S** key, then the image is freezing.

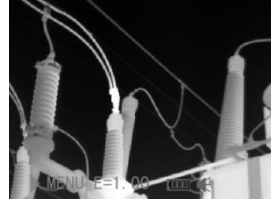

3 Press the **S** key again, then the image is active.

Shooting

Fulfill the Analysis Function

Setting object/global settings

- 2** Press the *MENU/ENTER* key, then press the *LEFT* or *RIGHT* arrow on the omni selector to select the [Analys.] menu.



- 3** Press *UP* or *DOWN* arrow on the omni selector to select [Obj.Par.], then press the [MENU/ENTER] key.

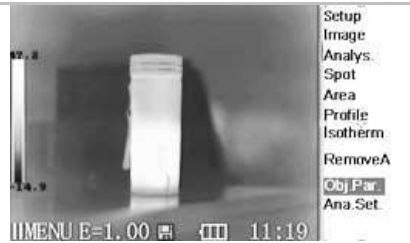

- 4** Setting analysis parameter.

- Press the *UP* or *DOWN* arrow on the omni selector to select an item to change.
- Press the *LEFT* or *RIGHT* arrow on the omni selector to set the values.



- 5** After this operation, press the *MENU/ENTER* key to save changes, or press the *C* key to go back to the upper menu without saving.



About the analysis parameters

Object	Selects the object of which you want to set the parameters.
Emiss	Different material has different emissivity. Use different emissivity to measure different material.
Distance	Different object has different distance to the IR camera. Use different distance to measure different object.
Amb Temp	Input ambient temperature.
Humidity	Input ambient humidity.
Comp Obj	Comp Obj1 can be set as any spot and area; Comp Obj2 can be set as ref. temp. and any spot and area. Differential of their temperature will be showed at the right bottom corner of the screen. For example, Comp Obj1 is Spot1(35.4°C) and Comp Obj2 is Ref Temp(30°C), then the final reading will be 5.4°C.
Ref Temp	Sets a reference temperature to compare with the spot/area/profile tool.



The reading of Comp. Obj



Reading

5.4

Shooting

Fulfill the Analysis Function

Setting analysis settings

- 1 Press the **MENU/ENTER** key, then press the **LEFT** or **RIGHT** arrow on the omni selector to select the [Analys.] menu.

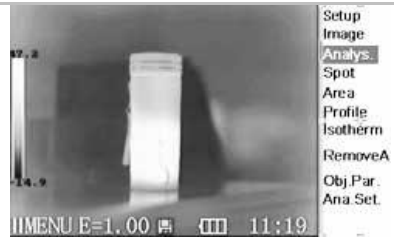

- 2 Press the **UP** or **DOWN** arrow on the omni selector to select the [Ana.Set] menu, then press the **MENU/ENTER** key.

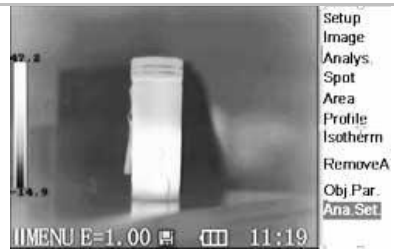

- 3 Setting analysis parameter.

- Press the **UP** or **DOWN** arrow on the omni selector to select an item to change.
- Press the **LEFT** or **RIGHT** arrow on the omni selector to set the values.



- 4 After this operation, press the **MENU/ENTER** key to save changes, or press the **C** key to go back to the upper menu without saving.



About the analysis settings

Alert	<p>There are two kinds of temp-alert: Upper-limit alert and Lower-limit alert.</p> <p>1.Upper-limit alert Set item "alert" as [on],and "Capture spot" as [maximum],then spot analysis tool "max sp10" will automatically capture the hottest spot within the screen, if this temperature is higher than the value you set in "alert temp",the reading on top-right screen will turn into RED.</p> <p>2.Lower-limit alert Set item "alert" as [on],and "Capture spot" as [minimum],then spot analysis tool "mini sp10" will automatically capture the coldest temperature within the screen,if this temperature is lower than the value you set in "alert temp",the reading on top-right screen will turn into RED.</p> <p>Note:select spot analysis tools [capture max.]&[capture min.] in menu"Analysis".</p>
Alert Temp	Sets the temperature limit of "Alert".
Correct Temp	Corrects the measured temperature value of the camera to ensure the measurement accuracy under special circumstances.
Saturation Color	When it's on, Green will take place of the color that stands for the highest temperature.
Isotherm Width	Sets the width of isothermal interval. The width can be adjusted from 0.1°C to the upper limit of the maximum temperature measurement range under this condition.
Isotherm Color	Sets the color of the isotherm interval. Transparent, Green, Black and White are available.

Sets the isothermal analysis mode. There are five modes: Dual Above, Dual Below, Above, Below and Interval.

**Isotherm
Type**

Dual Above	Display the isothermal interval in a color and the parts with the higher temperatures than the upper limit of the isothermal interval in a different color
Dual Below	Display the isothermal interval in a color and the parts with the lower temperatures than the lower limit of the isothermal interval in a different color
Above	Display the isothermal interval and the parts with the higher temperature than the upper limit of the isothermal interval in the same color
Below	Display the isothermal interval and the parts with the lower temperature than the lower limit of the isothermal interval in the same color
Interval	Display the isothermal interval in one color and all the other parts are displayed in the normal pseudocolor mode.

Shooting

Fulfill the Analysis Function

Setting analysis tools

This topic briefly explains how to set the analysis tools on the thermal image.

Spot analysis

- 1 Press the **MENU/ENTER** key, then press the **LEFT** or **RIGHT** arrow on the omni selector to select the **[Analys.]** menu.



- 2 Press the **UP** or **DOWN** arrow on the omni selector to select the **[Spot]** menu.



4 Setting the spot analysis.

- Press the **UP** or **DOWN** arrow on the omni selector to select a spot, then press **MENU/ENTER** key.
- Spot 10 will automatically track the hottest and coldest temperature spot within an area of which the shape and size can be set by the user. Press **LEFT** or **RIGHT** to select the Maximum spot or Minimum spot.



5 Moving the spot.

- Start from Step 1 to set or select an analysis spot.
- Press the **UP, DOWN, LEFT, RIGHT** arrow on the omni selector to move the activated spot.
- Press **Menu/Enter** key to fix the position of the spot.

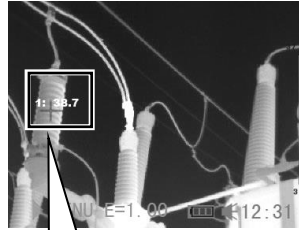

Temperature reading of spot changes in real-time.

Spot NO.

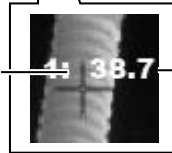

Temperature reading

6 Removing the spot

- Start from Step 1 to set or select an analysis spot.
- Press C key to remove the spot.

Shooting

Fulfill the Analysis Function

Area analysis

- 1 Press the **MENU/ENTER** key, then press the **LEFT** or **RIGHT** arrow on the omni selector to select the **[Analys.]** menu.

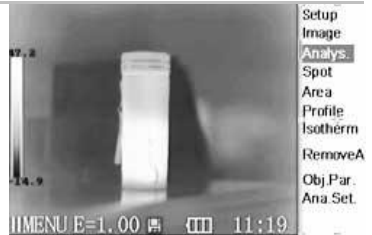

- 2 Press the **UP** or **DOWN** arrow on the omni selector to select the **[Area]** menu.

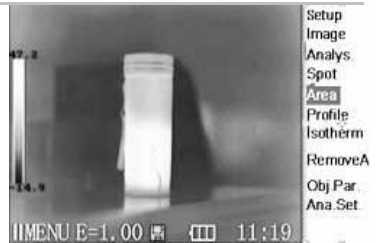

- 3 **Setting the analysis area.**

- Press the **UP** or **DOWN** arrow on the omni selector to select an area, then press **MENU/ENTER** key. One or more boxes will appear on the screen.
- A reading will appear at the top right corner. It is the reading of the highest/lowest/average temperature of the current area.
- H is short for highest temperature, L for lowest temperature, and A for average temperature.
- Press **LEFT** or **RIGHT** to select to show the Maximum or Minimum or Average temperature of the area.
- If Area 5 is selected, Maximum and Minimum and Average temperature of it will appear at the same time.



5 Moving the area.

- Start from Step 1 to set or select an analysis area.
- Press the **UP, DOWN, LEFT, RIGHT** arrow on the omniselector to move the activated area.

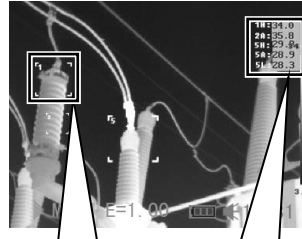

Temperature readings changes in real-time.

Area NO.

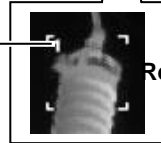

Readings

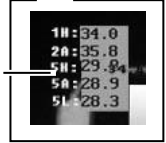

6 Removing the area

- Start from Step 1 to set or select an analysis area.
- Press C key to remove the activated area.



About changing the shape of the analysis area

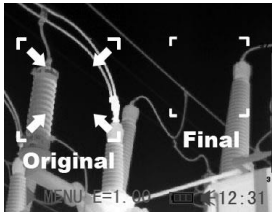

UPPER and LEFT arrow

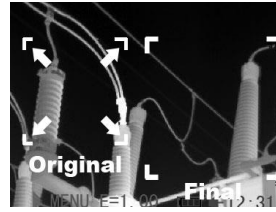

UPPER and RIGHT arrow



LOWER and LEFT arrow

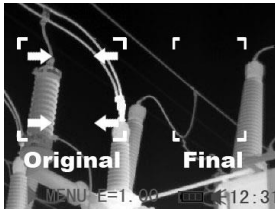

LOWER and RIGHT arrow

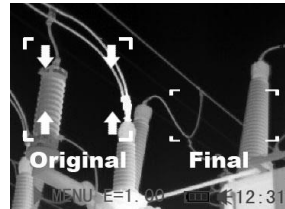

Shooting

Fulfill the Analysis Function

Profile analysis

- 1** Press the **MENU/ENTER** key, then press the **LEFT** or **RIGHT** arrow on the omni selector to select the **[Analys.]** menu.

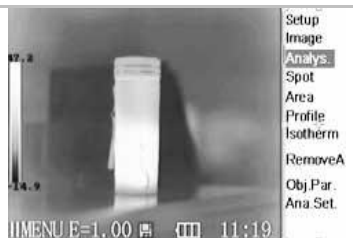

- 2** Press **UP** and **DOWN** arrow on the omni selector to select **[Profile]**, then press the **Menu/Enter** key. A profile will appear on the screen.



3 **Moving the profile analysis.**

- Start from Step 1 to set or select a profile analysis.
- Press the **UP** or **DOWN** arrow on the omni selector to move the profile.

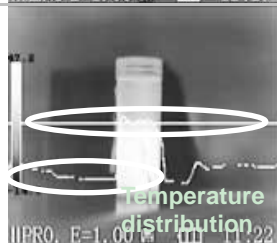

4 **Removing the profile analysis.**

- Start from Step 1 to set or select a profile analysis.
- Press **C** key to remove the activated profile.

Shooting

Fulfill the Analysis Function

Isotherm analysis

- 1** Press the **MENU/ENTER** key, then press the **LEFT** or **RIGHT** arrow on the omni selector to select the **[Analys.]** menu.

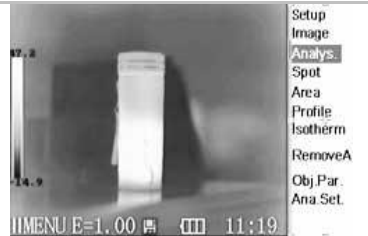

- 2** Press **UP** or **DOWN** arrow to select **[Isotherm]**, then press the **Menu/Enter** key. Areas of concern will be highlighted with color.

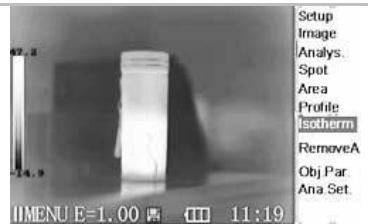

3 Setting isotherm range.

- Start from Step 1 to set or select isotherm analysis.
- Press the **UP** or **DOWN** arrow on the omni selector to select isotherm range.
- IL and IH will appear at the bottom right corner. It is the high limit (IH) and low limit (IL) of the isotherm range.

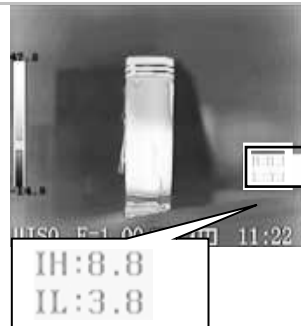

Shooting

Fulfill the Analysis Function

Remove analysis tools

This topic briefly explains how to remove analysis tools you place on the screen.

Remove analysis tools

- 1** Press the *MENU/ENTER* key, then press the *LEFT* or *RIGHT* arrow on the omni selector to select the [Analys.] menu.

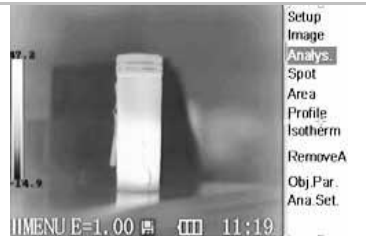

- 2** Press the *UP* or *DOWN* arrow on the omni selector to select [Remove All].
 - Press the *LEFT* or *RIGHT* arrow on the omni selector to select to remove all the spots/areas/profile or remove all the analysis tools

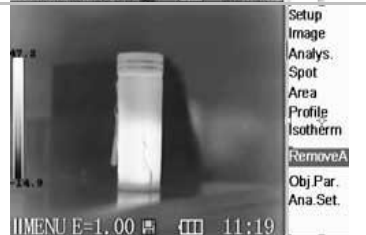

- 3** Press the *MENU/ENTER* key to remove all the analysis tools.



You can also delete a single analysis tool by pressing C key after selecting the analysis tool.

Shooting

Saving the Image

You can save the image in the menu system after you freeze an image, or save it directly by holding the **S** key on the omni selector for 3 seconds without freezing an image.

- 1** Press the *MENU/ENTER* key, then press the *LEFT* or *RIGHT* arrow on the omni selector to select the [File] menu.

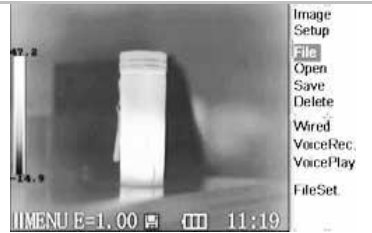

- 2** Press *UP* or *DOWN* arrow on the omni selector to select [Save], then press the *Menu/Enter* key to save the image.



The display mode decides the save image type.

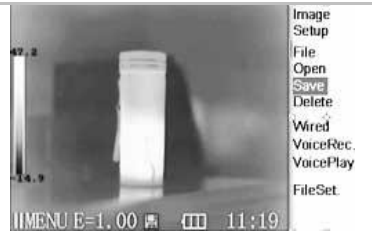

- 3** The name of saving image will be displayed on the screen.



The image will be saved in the current folder, p.58.

Shooting

Attaching Voice Memos to Images

You can introduce an image with voice recording.

Voice recording

You can attach voice memo to an image.

- 1 Install the headset or Bluetooth headset.
- 2 Freeze an image, then press the *MENU/ENTER* key.

- 3 Press the *LEFT* or *RIGHT* arrow on the omni selector to select the [File] menu.



- 4 Press *UP* or *DOWN* arrow on the omni selector to select [Voice REC.], then press the *Menu/Enter* key.

- The [Recording] message will appear on the LCD monitor.

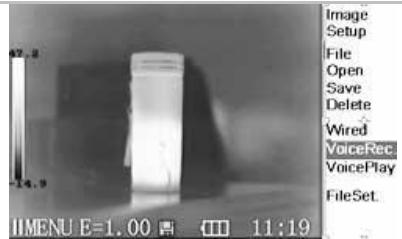

- 5 Speak toward the microphone of the headset. To stop recording, press the *C* key.

- 6 Save the image (p.54).



The storage capacity of the memory will not decrease when you attach voice comment to an image.

Playback and Erase

Opening Images

You can view and analyze the recorded images on the LCD monitor.

- 1 Press the **MENU/ENTER** key, then press the **LEFT** or **RIGHT** arrow on the omni selector to select the **[File]** menu.



- 2 Press **UP** or **DOWN** arrow on the omni selector to select **[Open]**, then press the **MENU/ENTER** key.

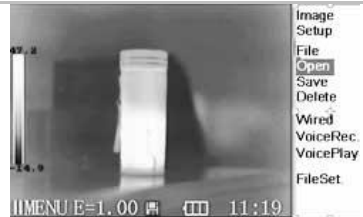

- 3 Press **LEFT** or **RIGHT** arrow on the omni selector to select an image, then press **MENU/ENTER** key to open it. How to select an image, refer to (p.57).

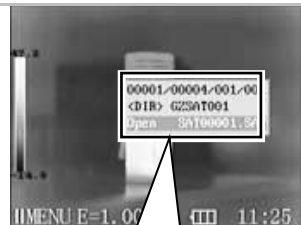

You can analyze and attach voice memo to a recorded image when you open it.



How to select an image

- 1 After you select **[Open]** or **[Delete]** option under **[File]** menu, a message shown as below will appear in the bottom-left screen.

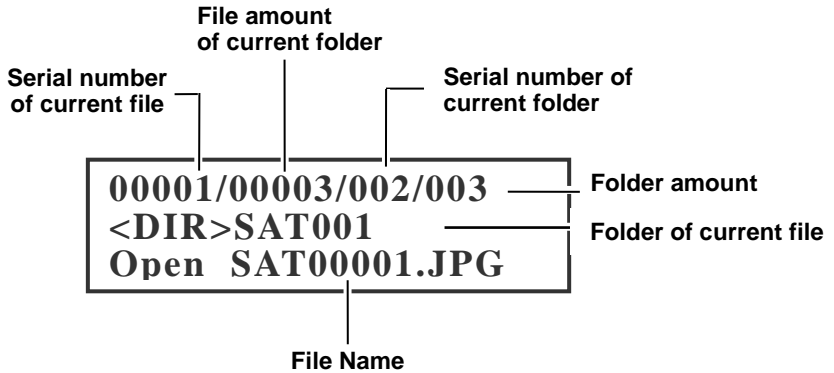

- 2 If the image you wish to open or delete is not in the current folder, press the **[LEFT]** or **[RIGHT]** arrow on the omni selector repeatedly to select the image.

- 3 Press the **S** key, you can activate the image.



Selecting the folder and filename

1 Press the *MENU/ENTER* key, then press the *LEFT* or *RIGHT* arrow on the omni selector to select the [File] menu.



2 Press the *UP* or *DOWN* arrow on the omni selector to select the [File Set] menu, then press the *MENU/ENTER* key.



3 Press the *UP* or *DOWN* arrow on the omni selector to select the [Directory Name] menu, then press the *LEFT* or *RIGHT* arrow to select the folder. [File number] is the number of file in current folder.



4 Press the *UP* or *DOWN* arrow on the omni selector to select the [File Name] menu, then press the *LEFT* or *RIGHT* arrow to select the filename.

Playback and Erase

Playback Memos

You can playback voice comment of an image when you attached a voice comment with it.

1 Attach the headset or Bluetooth headset.

2 Open an image, refer to (p.56).

3 Press the *MENU/ENTER* key, then press the *LEFT* or *RIGHT* arrow on the omni selector to select the [File] menu.



4 Press *UP* or *DOWN* arrow on the omni selector to select [Voice Play], then press the *Menu/Enter* key.

- A [Playing] message will appear on the LCD monitor.

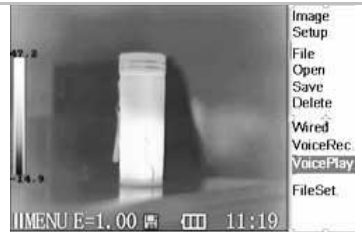

5 You can terminate the playback of voice comment by pressing the *C* key.

Playback and Erase

Erasing Images

-  Please note that erased images cannot be recovered. Exercise caution before erase an image.

- 1** Press the *MENU/ENTER* key, then press the *LEFT* or *RIGHT* arrow on the omni selector to select the [File] menu.

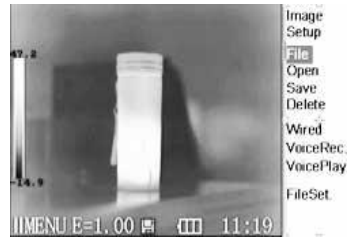

- 2** Press *UP* or *DOWN* arrow on the omni selector to select [Delete], then press the *MENU/ENTER* key.

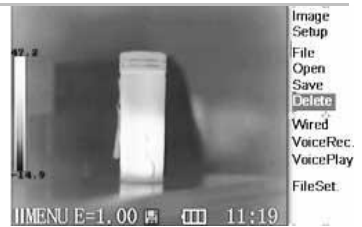

- 3** Select an image, refer to (p.57), then press *MENU/ENTER* key to delete the selected image.



- 4** Press the *C* key to exit.

Download the Images

Download the images via SD card

You can get the SD card out of camera, and download the images to the computer via the supplied SD card reader.

1 Open the battery / SD card cover.

2 Press the SD card lightly, then the SD card will pop-up automatically.

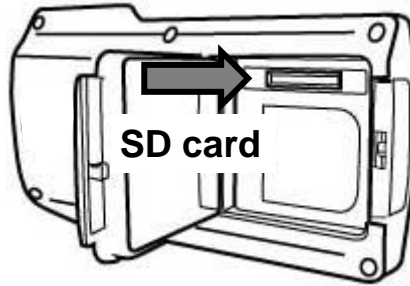

3 You can download the IR images via the supplied SD card reader.

Connection

Connecting to a Computer

Connection

Connect the USB cable (supplied) to the computer's USB port and the camera's terminal.



- You do not need to turn off the computer or camera when making this connection.
- Please refer to your computer manual for information regarding the location of the USB port.

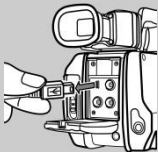
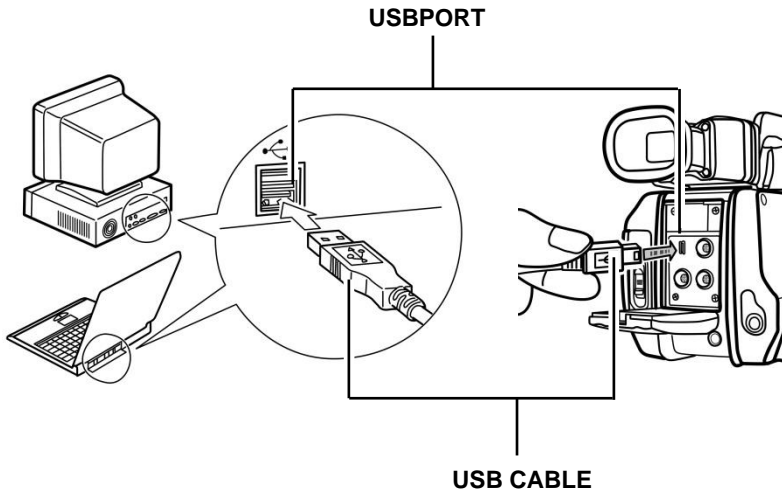

**To disconnect the cable from the IR camera:
Hold the cable connector firmly at both sides
and pull it straight out.**

Connection and Download

Real-time transfer

Installing the driver

Attach the supplied USB cable (optional) to the computer's USB port and the USB terminal of the camera. Set the real-time disk (optional) to the CD-ROM driver.

 Users of Windows XP Professional must first log in as an Administrator (computer system administrator) to install program.

1



After a few moments, the following dialog will appear.

2



Select **[No, not this time]** then click **[Next >]**.

3



Select **[Install from a list or location (Advanced)]** then click **[Next >]**.

4

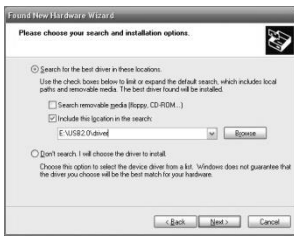

Select **[Include this location in the search]** then click **[browse]**. Locate the directory of the driver, and click **[Ok]** to return to the previous window. Then click **[Next>]**.

5



Click **[Continue Anyway]**.

6



Click **[Finish]** to finish the driver installation.

Connection and Download

Transfer Video via USB

You can analyze and save the thermal video in computer directly via the USB by the optional real-time software.

- 1** Power on the camera.
- 2** Connect the USB terminal of the camera and computer via USB cable.
- 3** The operation system will recognize the camera after install the driver.
- 4** You can analyze the real-time video, and save it in your computer's disk.

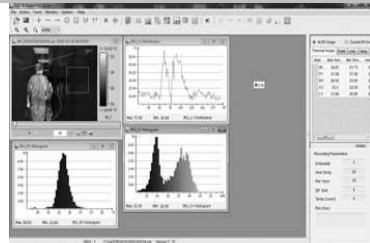

Connection and Download

Real-time transfer

Troubles shooting

When you have any problems in the process of connecting the IR camera to a computer to use optional real-time software, check this first.

First, Check the Following

1. Does your computer comply with these requirements?
Ensure the system has a built-in USB port and it comes with Windows XP pre-installed.
The USB interface is not supported for systems not complying with the above conditions.
2. Is the camera correctly connected to the computer?
See *Page 63* for connection instructions.
3. Is the battery charged sufficiently?
You should use a household power source to power the camera when it is connected to a computer.

• If the Problem Is Not Mentioned Above

If the USB Driver is not correctly installed, it is possible that Windows is not recognizing the USB Driver. Please contact your motherboard's manufacturer for the latest driver.

The USB 2.0 real-time transmission function may not properly work under some model of motherboard's chipset. In this case, connect the IR camera to another computer which is based on the chipset of Intel configuration or NVidia configuration and try again.

Connection and Download

Use the *Bluetooth headset

Follow the steps to install the Bluetooth headset (optional) first time.

1 Turn off the camera and Bluetooth headset.

2 Turn on the Bluetooth headset first. Press and hold the power button about 10seconds. And then you can see the power indicator begins to blink red and blue. The headset is in pairing status in 120 seconds.



3 Turn on the camera. You can see the green indicator of camera lights and the blue indicator flashes at the same time. In this mode, camera is preparing to pair the Bluetooth headset.

4 Press the power button of Bluetooth headset to pair the headset and camera. When the pairing is successful, blue indicator of the headset flashes slowly. Then you can see the Bluetooth icon  on the middle-bottom screen.

5 After pairing the camera and headset first time. In next time, turn on the headset to check the power indicator blinks blue, and then turn on the camera, you can use it.



Press **C** key and **Enter** key together to free the Bluetooth headset.

6 Wear the headset, you can record the voice memos (p.55) or play back the memos (p.59) now.

Connection to GPS

Use the GPS

Follow the instructions on the camera for the GPS

1 Turn on the GPS feature on the Camera

2 *The GPS feature will download the co-ordinates of the location once it has detected several satellites for an accurate reading.*

Should the signals from the satellites be weak in signal then the location will not be as accurate as when receiving a strong signal from the satellites

Troubles Shooting

Problem	Cause	Solution
Camera will not operate	Power is not turned on	<ul style="list-style-type: none"> • Turn on the camera. See <i>Turning the Power On / Off</i> (p.16).
	Insufficient battery voltage	<ul style="list-style-type: none"> • Fully charge the battery.
	Poor contact between camera and battery terminals	<ul style="list-style-type: none"> • Wipe the terminals with a clean, dry cloth.
Camera will not record	Internal memory is full	<ul style="list-style-type: none"> • If required, download the images to a computer and erase them to make some space.
	Internal memory not formatted correctly	<ul style="list-style-type: none"> • Format the internal memory in FAT32 format.
Battery pack consumed quickly	Battery pack capacity reduced because of disuse for one year or more after being fully charged.	<ul style="list-style-type: none"> • Replace the battery pack with a new one.
	Battery life exceeded	<ul style="list-style-type: none"> • Replace the battery pack with a new one
Battery pack will not charge	Poor contact between battery pack and battery charger.	<ul style="list-style-type: none"> • Clean the battery terminals with clean cloth. • Connect the power cord to the battery charger and insert its plug firmly into the power outlet.
	Battery life exceeded	<ul style="list-style-type: none"> • Replace the battery pack with a new one.

Appendix

Using the Optional Lens

The optional lenses are used to expand your analyze range.

 Ensure that the lens is screwed firmly onto the camera body. Injury from glass shards can occur if the lens loosens and falls off

48° Wide angle lens



This lens is for taking wide angle shots. The lens changes the focal length of the camera body's lens by a factor of 0.5x.

12° Tele-lens



This lens is for taking telephoto shots. The lens changes the focal length of the camera body's lens by a factor of 2x.

Appendix

Using the Optional Lens

How to mount optional lens

1 Turn off the IR camera (p.16).

2

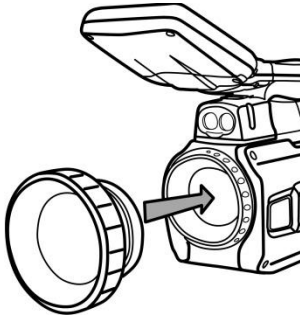

Attach the lens to the camera body.

3

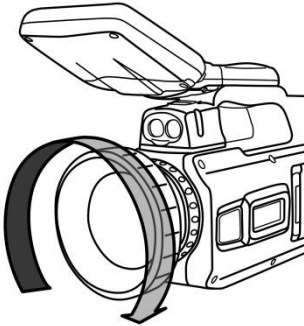

Screw on the lens in the direction of the arrow.

4

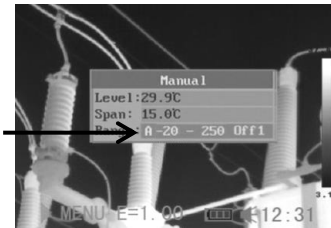

The camera will change the type of lens automatically when you replace the lens. Please see the measurement range.

Appendix

Camera Care and Maintenance

Use the following procedures to clean the camera body, lens, LCD monitor and other parts.

Camera Body	Wipe the body clean with soft cloth or eyeglass lens wiper.
Lens	First use a lens blower to remove dust and dirt, then remove any remaining dirt by wiping the lens lightly with soft cloth. <ul style="list-style-type: none">• Never use synthetic cleaners on the camera body or lens.
LCD monitor	Use a lens blower brush to remove dust and dirt. If necessary, gently wipe the LCD monitor with soft cloth or an eyeglass lens wiper to remove stubborn dirt. <ul style="list-style-type: none">• Never rub or press forcefully on the LCD monitor. These actions may damage it or lead to other problems.

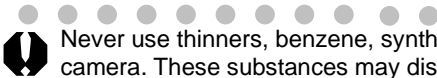

Never use thinners, benzene, synthetic cleaners or water to clean the camera. These substances may distort or damage the equipment.

Appendix

Emissivity table

Material	Temperature (°C)	Emissivity approximation
Metal		
Aluminum		
Polished aluminum	100	0.09
Commercial aluminum foil	100	0.09
Electrolytic chromeplate alumina	25 ~ 600	0.55
Mild alumina	25 ~ 600	0.10 ~ 0.20
Strong alumina	25 ~ 600	0.30 ~ 0.40
Brass		
Brass mirror (highly polished)	28	0.03
Brass oxide	200 ~ 600	0.61 ~ 0.59
Chrome		
Polished chrome	40 ~ 1090	0.08 ~ 0.36
Copper		
Copper mirror	100	0.05
Strong copper oxide	25	0.078
Cuprous oxide	800 ~ 1100	0.66 ~ 0.54
Liquid copper	1080 ~ 1280	0.16 ~ 0.13
Gold		
Gold mirror	230 ~ 630	0.02

Appendix

Emissivity table (continue)

Material	Temperature (°C)	Emissivity approximation
Iron		
Polished cast iron	200	0.21
Processed cast iron	20	0.44
Polished tempered iron	40 ~ 250	0.28
Polished steel ingot	770 ~ 1040	0.52 ~ 0.56
Raw welded steel	945 ~ 1100	0.52 ~ 0.61
Surface ferric oxide	20	0.69
Completely rusty surface	22	0.66
Rolled iron plate	100	0.74
Oxidized steel	198 ~ 600	0.64 ~ 0.78
Cast iron (Oxidizing at 600°C)	198 ~ 600	0.79
Steel (Oxidizing at 600°C)	125 ~ 520	0.78 ~ 0.82
Electrolytic ferric oxide	500 ~ 1200	0.85 ~ 0.89
Iron plate	925 ~ 1120	0.87 ~ 0.95
Cast iron, heavy ferric oxide	25	0.80
Tempered iron, ferric oxide	40 ~ 250	0.95
Melting surface	22	0.94
Melting cast iron	1300 ~ 1400	0.29
Melting mild steel	1600 ~ 1800	0.28
Liquid steel	1500 ~ 1650	0.42 ~ 0.53

Pure liquid iron	1515 ~ 1680	0.42 ~ 0.45
------------------	-------------	-------------

Appendix

Emissivity table (continue)

Material	Temperature (°C)	Emissivity approximation
Lead		
Pure lead (Non-oxidization)	125 ~ 225	0.06 ~ 0.08
Mildly oxidized	25 ~ 300	0.20 ~ 0.45
Magnesium		
Magnesia	275 ~ 825	0.55 ~ 0.20
Magnesia	900 ~ 1670	0.20
Hg	0 ~ 100	0.09 ~ 0.12
Nickel		
Electroplate polishing	25	0.05
Electroplate	20	0.01
non-polishing		
Nickel wire	185 ~ 1010	0.09 ~ 0.19
Nickel plate (oxidized)	198 ~ 600	0.37 ~ 0.48
Nickel oxide	650 ~ 1255	0.59 ~ 0.86
Nickel alloy		
Nickel-chrome (heat-resistance) alloy wire (shining)	50 ~ 1000	0.65 ~ 0.79
Nickel-chrome alloy	50 ~ 1040	0.64 ~ 0.76
Nickel-chrome (heat resistance)	50 ~ 500	0.95 ~ 0.98

Nickel-silver alloy	100	0.14
Silver		
Polished silver	100	0.05

Appendix

Emissivity table (continue)

Material	Temperature (°C)	Emissivity approximation
Stainless steel		
18-8	25	0.16
304(8Cr,18Ni)	215 ~ 490	0.44 ~ 0.36
310(25Cr,20Ni)	215 ~ 520	0.90 ~ 0.97
Tin		
Commercial tin plate	100	0.07
Strong oxidization	0 ~ 200	0.60
Zinc		
Oxidizing at 400°C	400	0.01
galvanized shining iron plate	28	0.23
Ash zinc oxide	25	0.28
Non-metal materials		
Brick	1100	0.75
Fire brick	1100	0.75
Graphite (lamp black)	96 ~ 225	0.95
Porcelain enamel (white)	18	0.90
Asphaltum	0 ~ 200	0.85
Glass (surface)	23	0.94

Heat-resistance glass	200 ~ 540	0.85 ~ 0.95
Calcimine	20	0.90
Oak	20	0.90

Appendix

Emissivity table (continue)

Material	Temperature (°C)	Emissivity approximation
Carbon piece		0.85
Isolation piece		0.91 ~ 0.94
Sheet metal		0.88 ~ 0.90
Glass pipe		0.90
Loop type		0.87
Porcelain enamel products		0.90
Porcelain enamel designs		0.83 ~ 0.95
Solid materials		0.80 ~ 0.93
Ceramics (vase type)		0.90
Film		0.90 ~ 0.93
Mica		0.94 ~ 0.95
Flume mica		0.90 ~ 0.93
Glass		0.91 ~ 0.92
Semiconductor		0.80 ~ 0.90
Transistor (plastics sealed)		0.30 ~ 0.40
Transistor (metal Diode)		0.89 ~ 0.90
Transmitting loop		
Pulse transmission		0.91 ~ 0.92
Level chalkiness layer		0.88 ~ 0.93
Top loop		0.91 ~ 0.92

Appendix

Emissivity table (continue)

Material	Temperature (°C)	Emissivity approximation
Electric materials		
Epoxy glass plate		0.86
Epoxy hydroxybenzene plate		0.80
Gilded sheet copper		0.30
Solder-coated copper		0.35
Tin-coated lead wire		0.28
Brass wires		0.87 ~ 0.88
Block talcum terminal		0.87

Specification

All data is based on SATIR's testing standard. Subject to change without notice.

Type	G96-Plus
Image performance	
FOV/Min.focus distance	24° x18°/0.5m
Spatial resolution	0.65mrad
Thermal sensitivity	≤0.03°C@30°C
Detector type	UFPA
Resolution	640x480
Spectral range	8-14um
Focus	Motorized, Auto-focus
Image presentation	
Image mode	IR/CCD/Duo-vision/PiP
LCD Display	5" TFT screen
Digital camera	640 x 480 full color
Viewfinder	640 x 480 full color
Video output	NTSC (60Hz) or PAL (50Hz) composite video
Temperature measurement	
Measurement range	-20°C ~ +600°C, up to +2000°C (optional)
Accuracy	±2°C, ±2% of readings

Measurement mode	9 movable spots, auto hot/cold spot, profile, 4 area boxes, isotherm
Correction	Emissivity, ambient temperature, distance, relative humidity
Delta T	Yes
Alarm	Yes
Image storage	
Type	4GB removable SD card
File format- Thermal	.JPG
File format- Visual	.CCD
Thermal video record	MPEG Format
Annotation	Voice annotation via Bluetooth
Battery system	
Working voltage	DC 8V-11V
Battery operating time	2.5 hours
Environment specification	
Operating temperature range	-20°C to +50°C
Storage temperature range	-40°C to +70°C
Humidity	10% to 95%, non-condensing
Encapsulation	IP54
Shock	25G
Vibration	2G

Physical characteristic	
Weight	1740g
Size	327mm X 143mm X 170mm
Tripod mounting	1/4" _20
Other	
GPS	Yes
Illuminator	Yes
Laser pointer	Yes
USB Type C	Yes
Bluetooth	Yes
Available optional lenses	12°, 48°

Manufacturer Information

SATIR Europe (Ireland) Co. Ltd

Marley's Business Park

Marley's Lane

Drogheda

Co. Louth

Ireland

TEL: +353 (0)41 9844371

URL: www.satir.com

E-Mail: service@satir.com